



MASTERWELD

www.masterweld.co.uk

KM 501 M-Power Water-Cooled

OPERATOR MANUAL

Welcome

Thank you and congratulations on choosing MasterWeld. This Owner's Manual is designed to help you get the most out of your MasterWeld products.

Please take time to read the Safety precautions. They will help you protect yourself against potential hazards in the workplace. With proper maintenance this equipment should provide years of reliable service. All our systems conform to ISO9001: 2015 and are independently audited by TCS.

The entire product range carries the CE mark, and is constructed in accordance with European directives and the product specific standards where they apply.

For more information about MasterWeld's complete range visit: www.masterweld.co.uk

Contents

1.0	Safety Precautions	4
2.0	Product Description	5
3.0	Technical Specifications	6
4.0	Description of Controls	6
4.1	Symbols and Definitions	6
4.2	Description of the Machine Wire Feeder	7
4.3	Device Control	8
5.0	Installation	9
5.1	Unpacking the Machine	9
5.2	Location	9
5.3	Input and Grounding Connection	9
5.4	Output Polarity Connections	9
5.5	Torch Cooling	9
5.6	Maximum Hose Pack Length	9
5.7	Hose Pack Connection	9
5.8	Gas Testing	10
5.9	Changing Drive Roll Sets	10
5.10	Welding Wire Installation	10
5.11	Torch Installation	11
5.12	Work Return Lead Connection	11
5.13	Shielding Gas Connection	11
6.0	Operation	12
6.1	Operation Selecting the JOB	12
6.2	Operation (2T)	12
6.3	Operation (4T)	12
6.4	Operation (S4T)	12
6.5	Operation Smart Trigger	12
6.6	MIG Operation	13
6.7	MMA Welding	13
6.8	Basic TIG Welding Guide	14
6.9	Additional Functions	14
7.0	Fault Finding	18
7.1	Repair and Maintenance	20
7.2	Error Codes	20
8.0	Accessories	21
8.1	Gas Equipment	21
8.2	Feed Rolls	21
9.0	EC Declaration of Conformity	22
9.1	RoHS Compliance Declaration	22
9.2	WEEE Statement	23
9.3	Statement of Warranty	23

1.0 Safety Precautions

ELECTRIC SHOCK can kill.

Touching live electrical parts can cause fatal shocks or severe burns. The electrode and work circuit are electrically live whenever the output is on. The input power circuit and machine internal circuits are also live when power is on. In semiautomatic or automatic wire welding, the wire, wire reel, drive roll housing, and all metal parts touching the welding wire are electrically live. Incorrectly installed or improperly grounded equipment is a hazard.

Do not touch live electrical parts.

Wear dry, sound insulating gloves and body protection.

Insulate yourself from work and ground using dry insulating mats or covers big enough to prevent any physical contact with the work ground.

Additional safety precautions are required when any of the following electrically hazardous conditions are present: in damp locations or while wearing wet clothing; on metal structures such as floors, gratings, or scaffolds; when in cramped positions such as sitting, kneeling, or lying; or when there is a high risk of unavoidable or accidental contact with the work piece or ground. For these conditions, use the following equipment in order presented: 1) a semiautomatic DC constant voltage (wire) welder, 2) a DC manual (stick) welder and do not work alone!

Disconnect input power before installing or servicing this equipment. Lockout/tagout input power according to Safety Standards.

Properly install and ground this equipment according to national and local standards.

Always verify the supply ground - check and ensure that input power cable ground wire is properly connected to ground terminal in the receptacle outlet.

When making input connections, attach proper grounding conductor first - double-check connections.

Frequently inspect input power cable for damage or bare wiring - replace cable immediately if damaged - bare wiring can kill.

Turn off all equipment when not in use.

Do not use worn, damaged, under sized, or poorly spliced cables.

Do not drape cables over your body.

If earth grounding of the work piece is required, ground it directly with a separate cable.

Do not touch electrode if you are in contact with the work, ground, or another electrode from a different machine.

Use only well-maintained equipment. Repair or replace damaged parts at once. Maintain unit according to manual.

Wear a safety harness if working above floor level.

Keep all panels and covers securely in place.

Clamp work cable with good metal-to-metal contact to work piece or worktable as near the weld as practical.

Insulate work clamp when not connected to work piece to prevent contact with any metal object.

Welding produces fumes and gases. Breathing these fumes and gases can be hazardous to your health.

FUMES AND GASES can be hazardous.

Keep your head out of the fumes. Do not breathe the fumes.

If inside, ventilate the area and/or use local forced ventilation at the arc to remove welding fumes and gases.

If ventilation is poor, wear an approved respirator.

Read and understand the Material Safety Data Sheets (MSDS's) and the manufacturer's instructions for metals, consumable, coatings, cleaners, and de-greasers.

Work in a confined space only if it is well ventilated, or while wearing an air-supplied respirator. Always have a trained watch person nearby. Welding fumes and gases can displace air and lower the oxygen level causing injury or death. Be sure the breathing air is safe.

Do not weld in locations near de-greasing, cleaning, or spraying operations. The heat and rays of the arc can react with vapours to form highly toxic and irritating gases.

Do not weld on coated metals, such as galvanised, lead, or cadmium plated steel, unless the coating is removed from the weld area, the area is well ventilated, and while wearing an air-supplied respirator. The coatings and any metals containing these elements can give off toxic fumes if welded.

ARC RAYS can burn eyes and skin.

Arc rays from the welding process produce intense, visible and invisible (ultraviolet and infrared) rays that can burn eyes and skin. Sparks fly off from the weld.

Wear an approved welding helmet fitted with a proper shade of filter lenses to protect your face and eyes when welding or watching

Wear approved safety glasses with side shields under your helmet.

Use protective screens or barriers to protect others from flash, glare and sparks; warn others not to watch the arc.

Wear protective clothing made from durable, flame resistant material (leather, heavy cotton, or wool) and foot protection. Welding on closed containers, such as tanks, drums, or pipes, can cause them to blow up. Sparks can fly off from the welding arc. The flying sparks, hot work piece, and hot equipment can cause fires and burns. Accidental contact of electrode to metal objects can cause sparks, explosion, overheating, or fire. Check and be sure the area is safe before doing any welding.

WELDING can cause fire or explosion.

Remove all flammables within 10m of the welding arc. If this is not possible, tightly cover them with approved covers.

Do not weld where flying sparks can strike flammable material.

Protect yourself and others from flying sparks and hot metal.

Be alert that welding sparks and hot materials from welding can easily go through small cracks and openings to adjacent areas.

Watch for fire and keep a fire extinguisher nearby. Be aware that welding on a ceiling, floor, bulkhead, or partition can cause fire on the hidden side.

Do not weld on closed containers such as tanks, drums, or pipes, unless they are properly prepared according to local regulations

Connect work cable to the work as close to the welding area as practical to prevent welding current from travelling along, possibly unknown paths and causing electric shock, sparks, and fire hazards.

Cut off welding wire at contact tip when not in use.

Wear oil-free protective garments such as leather gloves, heavy shirt, cuffless trousers, high shoes, and a cap. Remove any combustibles, such as a butane lighter or matches, from your person before doing any welding.

FLYING METAL can injure eyes.

Welding, chipping, wire brushing, and grinding cause sparks and flying metal. As welds cool, they can throw off slag. Wear approved safety glasses with side shields even under your welding helmet.

BUILDUP OF GAS can injure or kill.

Shut off shielding gas supply when not in use. Always ventilate confined spaces or use approved air-supplied respirator.

HOT PARTS can cause severe burns.

Do not touch hot parts with bare hands.

Allow cooling period before working on gun or torch.

To handle hot parts, use proper tools and/or wear heavy, insulated welding gloves and clothing to prevent burns.

MAGNETIC FIELDS can affect pacemakers.

Pacemaker wearers keep away.

Wearers should consult their doctor before going near arc welding, gouging, or spot-welding operations.

NOISE can damage hearing.

Noise from some processes or equipment can damage hearing.

Wear approved ear protection if noise level is high.

Shielding gas cylinders contain gas under high pressure.

CYLINDERS can explode if damaged.

Protect compressed gas cylinders from excessive heat, mechanical shocks, physical damage, slag, open flames, sparks, and arcs. Install cylinders in an upright position by securing to a stationary support or cylinder rack to prevent falling or tipping. Keep cylinders away from any welding or other electrical circuits. Never drape a welding torch over a gas cylinder. Never allow a welding electrode to touch any cylinder. Never weld on a pressurised cylinder - explosion will result. Use only correct shielding gas cylinders, regulators, hoses, and fittings designed for the specific application; maintain them and associated parts in good condition.

Turn face away from valve outlet when opening cylinder valve.

Use the right equipment, correct procedures, and sufficient number of persons to lift and move cylinders.

Read and follow instructions on compressed gas cylinders, associated equipment, and Compressed Gas Association (CGA).











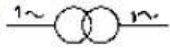





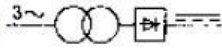











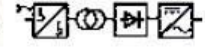





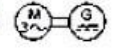





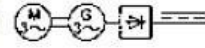





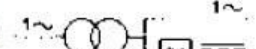











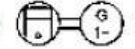





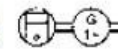

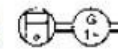

2.0 Product Description

The MasterWeld KM 501 M-Power Water-Cooled is a complete semiautomatic constant voltage DC arc welding machine built to meet CE specifications. It combines a constant voltage power source and a constant speed wire feeder with a microcomputer-based controller to form a reliable high-performance welding system. A simple control scheme, consisting of voltage and wire feed speed controls, provides versatility with ease of use and accuracy. Other features include wire reel spindle with adjustable brake for 15kg wire spools (300mm), an integral gas cylinder mounting undercarriage, an adjustable Argon flow regulator with cylinder pressure gauge and inlet hose, a MIG torch, and a 3.0m work cable with clamp.

3.0 Technical Specifications

The MasterWeld KM 501 M-Power Water-Cooled is a separate type of machine with separate wire feed units for use with three phase 400V supply. The machine uses inverter technology to allow MIG, TIG and MMA welding to be performed.

4.0 Description of Controls

① 	⑫ 	⑳ 	㉓ 	㉖ A	㉙ 
② 	⑬ 	㉑ 	㉔ 	㉗ V	㉚ 
③ 	⑭ 	㉒ 	㉕ 	㉘ V	㉛ 
④ 	⑮ 	㉓ 	㉖ 	㉙ 	㉜ 
⑤ 	⑯ 	㉔ 	㉗ 	㉚ 	㉝ 
⑥ 	⑰ 	㉕ 	㉘ 	㉜ 	㉞ 
⑦ 	⑱ 	㉖ 	㉙ 	㉝ 	㉟ 
⑧ 	㉒ 	㉗ 	㉚ 	㊱ 	
⑨ 	㉓ 	㉘ 	㉜ 		
⑩ 	㉔ 	㉙ 	㉝ 		
⑪ 	㉕ 	㉚ 	㉞ 		
	㉖ 	㉜ 	㉟ 		
	㉗ 	㉝ 			
	㉘ 	㉞ 			
	㉙ 	㉟ 			
	㉚ 				
	㉜ 				
	㉝ 				
	㉞ 				
	㉟ 				

4.1 Symbols and Definitions

- | | |
|---|---|
| 1. Manual Metal Arc welding | 23. Internal combustion engine |
| 2. TIG welding | 24. Motor |
| 3. MIG welding | 25. Belt drive |
| 4. Self-shielded flux-core arc welding | 26. Amps |
| 5. Submerged arc welding | 27. Voltage |
| 6. Plasma cutting | 28. Voltage input |
| 7. Arc gouging | 29. Voltage output |
| 8. Plasma welding | 30. Positive |
| 9. Direct current | 31. Negative |
| 10. Alternating current | 32. Open circuit voltage |
| 11. Accurate or alternating current at the same output and additional frequency of Hz | 33. Mains voltage |
| 12. Single-phase transformer | 34. Load voltage |
| 13. Three phase transformers with rectifier | 35. Maximum current drawn from the supply |
| 14. Single or three-phase static frequency inverter - transformer - rectifier | 36. Maximum line current under load |
| 15. AC or DC Inverter power supply | 37. Welding current under load |
| 16. Three-phase motor - generator | 38. Percent |
| 17. Three-phase motor - generator - rectifier | 39. Suitable for environments with increased risk of electric shock |
| 18. Three-phase rotary frequency inverter | 40. Hertz |
| 19. Single-phase combined AC and DC power unit | 41. Temperature |
| 20. Internal combustion engine - generator | 42. Increment / Decrease setting |
| 21. Internal combustion engine - generator - rectifier | 43. Duty Cycle |
| 22. Supply circuit, number of phases (e.g., 1 or 3), alternating | 44. On |
| | 45. Off |

4.2 Description of the machine wire feeder

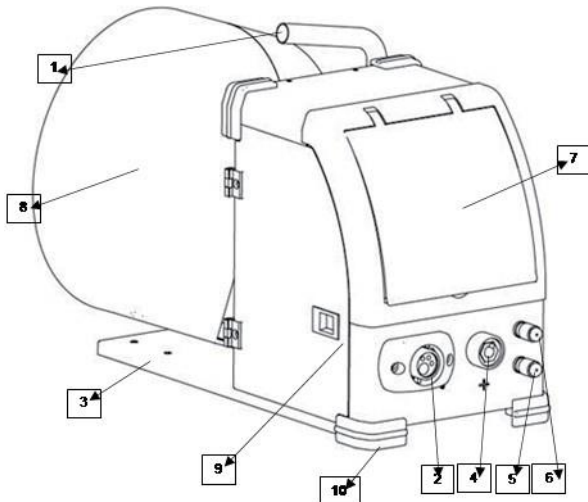

1. Handle
2. Welding Torch Connection
3. Machine Feet mounting locations
4. Connection Socket for electrode
5. Cooling water back flow connection (Red)
6. Cooling water forward flow connection (Blue)
7. Welding machine control panel and protective cover
8. Welding wire Plastic Cover
9. Wire feed box door
10. Plastic Front protector

Internal View

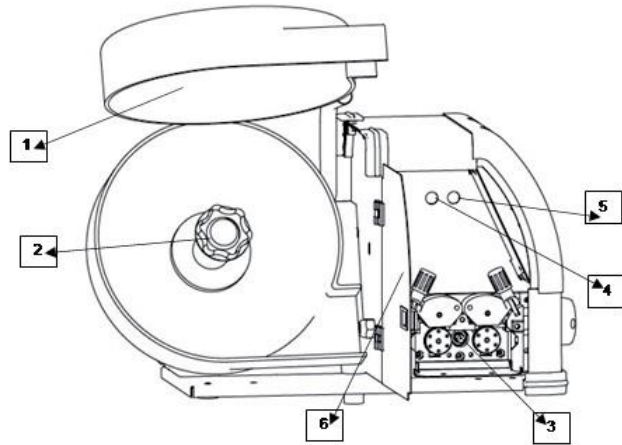

1. Wire spool protective cover
2. Wire spool hub
3. Wire feed box
4. Wire loading button
5. Gas test button
6. Wire-feed door

Rear View

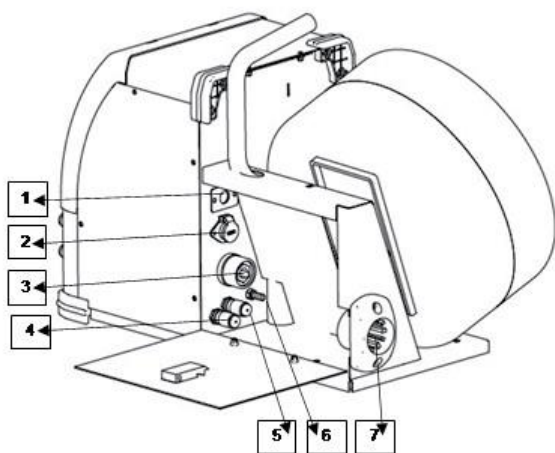

1. Connection (Trigger) socket
2. Communication socket
3. Power supply welding current connection socket
4. Coolant back flow connection (Red)
5. Cooling water forward flow connection (Blue)
6. Gas connection
7. Support Bush



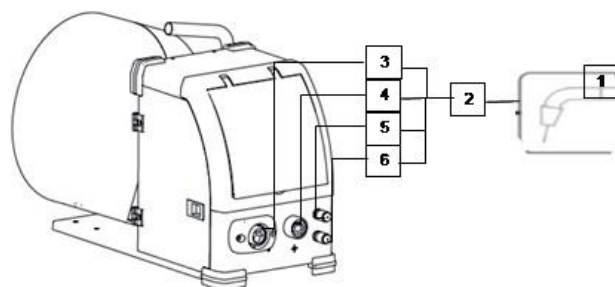





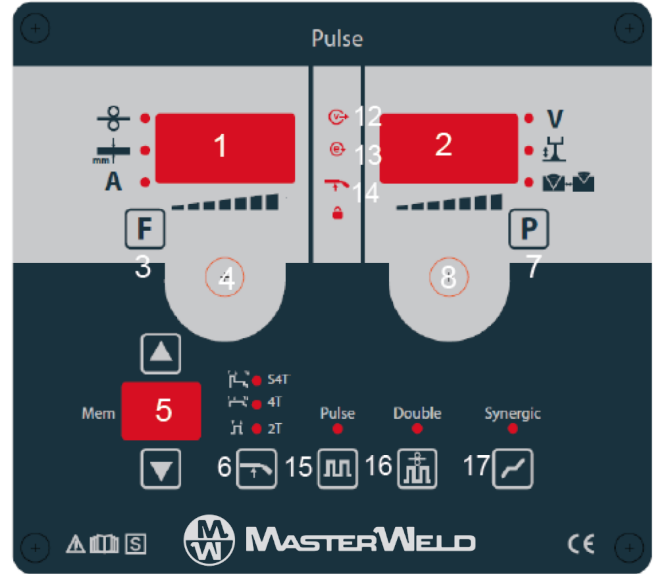
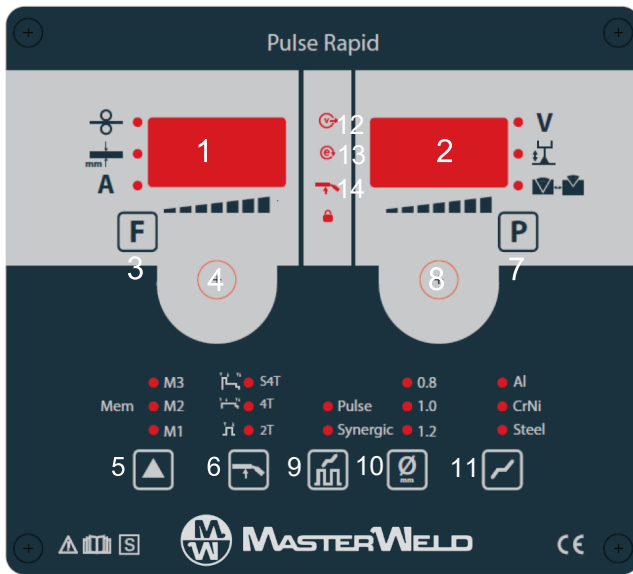

Wire feed unit front panel











1. Welding Torch
2. Welding Torch hose package
3. Welding torch connection
4. Connection Socket for MMA welding
5. Cooling water back flow (Red)
6. Cooling water flow forward (Blue)

4.3 Device Control



1		Three Digit Display, left	
			Wire feed speed
2		Three Digit Display, right	
			Set weld Voltage and trim of weld voltage
3		Open the function options (press of 5 seconds)	
			Current value during welding
4		Rotary button, adjustment of welding parameters	
			Wire feed speed, material thickness and amperage
5		Trigger mode selection	
			4 T Operation 2 T Operation Hold this button for 5 sec for Electrode Mode

6			Welding voltage
			Trim of welding voltage (+) Arc harder and narrower (-) Arc softer and wider
7			Inductance (Arc Dynamics) (+) Arc harder and narrower (-) Arc softer and wider
		Changing the source voltage value	
8		Changing function values	
9		Power output is on	
10		The LED lights up if the encoder information is not displayed	
		When the trigger is triggered, the LED is lit	

5.0 Installation

Read entire installation section before starting installation.

SAFETY PRECAUTIONS

- ELECTRIC SHOCK can kill.
- Only qualified personnel should perform this installation.
- Only personnel that have read and understood the Operating Manual should install and operate this equipment.
- Machine must be grounded per any national, local or other applicable electrical regulations.
- The MIG power switch is to be in the OFF position when installing work cable and torch and when connecting other equipment.

5.1 Unpacking the Machine

Cut banding and lift off cardboard carton. Cut banding holding the machine to the skid. Remove corrugated packing material. Remove accessories from Gas Bottle Platform. Roll the machine off the skid.

5.2 Location

Locate the welder in a dry location where there is free circulation of clean air into the louvres in the back and out the front. A location that minimises the amount of smoke and dirt drawn into the rear louvres reduces the chance of dirt accumulation that can block air passages and cause overheating.

5.3 Input and Grounding Connection

WARNING

Before starting the installation, check that your power supply is adequate for the voltage, amperage, phase, and frequency specified on the Machine nameplate.

The 400-volt 50 Hz machine is supplied with a 3m input cable and without plug, ensure that you connect a plug that is suitably rated for the power draw of the machine and the environmental location.

Have a qualified electrician connect the input plug. For long runs over 30m, larger copper wires should be used. The green/yellow wire in the input cable connects to the frame of the machine. This ensures proper grounding of the machine when the machine plug is inserted into the receptacle.

5.4 Output Polarity Connections

MIG, TIG and MMA welding use different electrode polarities. The polarity of the MIG torch can be selected by connection of the torch cable to the + or - socket the front of the welder, (+) polarity. This is the normal polarity for MIG welding with GAS.

5.5. Torch Cooling

Coolant liquids!

The use of unsuitable coolants will result in damage and void the manufacturer's warranty!

- Only use the coolants specified in this manual.
- Do not mix different coolants.
- Replace the entire fluid when changing the coolant.

Insufficient antifreeze in the welding torch coolant can damage the machine. The coolant must be checked at regular intervals for the amount of antifreeze and thus avoid any damage to the machine and its accessories.

Only use MasterWeld coolant

5.6 Maximum Hose Pack Length

The maximum length of the intermediate hose package is 40 m due to the cooling pump operating pressure.

WARNING

- The welding power cables that are improperly installed can cause faults on the arc!
- The hose package and the work piece return cable should be routed as long as possible, adjacent and parallel.
- To avoid mutual interactions. Observe the minimum distance of 20 cm.
- Cable lengths should not be longer than required. Maximum 30 m for ideal welding results. (Work piece + intermediate hose package + torch line).
- Use a separate work return cable for each welding machine.
- Fully uncoil welding current lines, welding torches and intermediate hose packages.
- Cable lengths should not be longer than required.

5.7 Hose Pack Connection

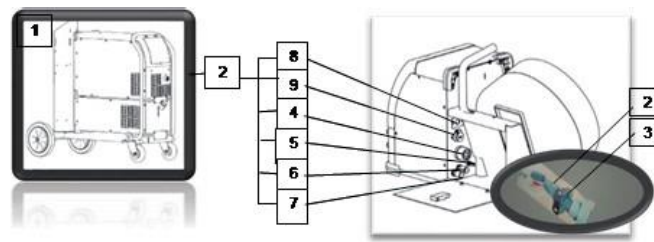

1. Power Source
2. Intermediate Hose Package
3. Cable Clamp
4. Power supply welding current connection socket
5. Shielding gas connection
6. Cooling water back flow (Red)
7. Cooling Water back flow forward (Blue)
8. Connection (Trigger) socket
9. Communication socket

- The hose package end should be passed through the intermediate hose package tensioner and fastened as indicated by the cable clamp belt.
- Insert the welding current wiring connector into the "welding current connection socket" and lock it by turning to the right.
- Install the cover nut of the shielding gas line to the G $\frac{1}{4}$ Thread fitting.
- Insert the cable connector of the control line into the connection socket and secure with the nut (the socket can only be inserted into the connection socket in one position).
- Fit the connection of the coolant hoses to the appropriate quick couplings: red (coolant back flow) to the quick connector and blue quick connector (coolant supply).

ATTENTION

Machine damage can be caused by improperly connected coolant lines!

In the case of improperly connected coolant lines or if a gas-cooled welding torch is used, the cooling circuit is interrupted, and machine damage may occur.

- Connect all cooling lines properly!
- Complete the hose package and the torch hose package.
- Pay attention to the maximum hose package length!
- If using a gas-cooled welding torch, disconnect the cooling unit at the rear of the machine.

5.8 Gas Testing

- Open the gas cylinder valve slowly.
- Open the pressure reducer.
- Switch on the power supply from the main switch.
- Press the gas test function on the wire feeder.
- Adjust the amount of gas in the flow meter according to the application.
- The gas test is activated by briefly pressing the button on the wire feed unit. The shielding gas flows for about 25 seconds or until the button is pressed again.

Setting the amount of shielding gas welding method recommended amount of shielding gas

MAG welding Wire diameter x 11.5 = l / min

MIG brazing Wire diameter x 11.5 = l / min

MIG welding (aluminium) Wire diameter x 13.5 = l / min
(100% argon) Gas nozzle diameter in TIG mm is equal to l / min gas flow

Incorrect protective gas adjustment!

A too low or too high a shielding gas setting can cause air to reach the welding pool, resulting in the formation of pores.

- Adjust the shielding gas amount according to the welding task!

Source information display.

The "Parameter selection" keys are located on the left and right of the machine control unit. These keys are used to select the source parameters shown.

Each time the button is pressed, the display changes to the next parameter (the LEDs next to the key indicate the selection). Once the last parameter is reached, the first parameter is restarted.

The following are shown.

- Nominal Values (Before welding)
- Actual Values (During welding)
- Hold values (After welding)

5.9 Changing Drive Roll Sets

1. Turn off the power source.
2. Release the pressure on the idle rolls by swinging the adjustable pressure arm down. Lift the cast idle roll assembly and allow it to sit in an upright position.

3. Unscrew the plastic knob retaining the lower grooved drive roll and side off the drive roller
4. Ensure the wire size marked on the side of the feed roller matches the wire size to be used.
5. Replace the drive rolls in reverse of the above procedure ensuring the wire size to be used is marked on the outward facing side of the roller as it is refitted.

NOTE: Be sure that the torch liner and contact tip are also sized to match the selected wire size.

5.10 Welding Wire Installation

As a factory delivery, the Euro connection is equipped with a capillary tube for welding torches with spiral liners. If a welding torch with plastic liner is used the capillary tube should be removed.

- Use a steel guide tube to weld hard, unalloyed wire electrodes (steel).
- Use a chrome nickel guide spiral to weld hard, high-alloyed wire electrodes (CrNi).
- Use extension of torch liner for welding or soldering soft wire electrodes, high-alloy wire electrodes or aluminium materials.

Preparation for connecting welding torches with manual spirals:

- Check that the central connection is seated in the capillary tube!

Preparations for the connection of welding torches with torch liner extension.

- Push the capillary tube forward in the direction of the central connection by the wire feed and remove it here.
- Shorten the liner extension just before the wire feed roller with a knife.
- Loosen the centre socket of the welding torch and pull it out.
- Clean and sharpen the separated end of the wire liner
- Open the wire drum cover by pulling down and out on the bottom of the cover
- Unscrew the plastic retaining wheel from the end of the spool holder shaft.
- Position the wire spool so that it will rotate in a direction when feeding to be de-reeled from the bottom of the coil.
- Slide the wire spool all the way onto the shaft and refit the plastic retaining nut.

NOTE: There is a friction brake on the reel hub assembly, to prevent the wire spool over running. When welding stops ensure the nut is slackened to the minimum setting. It can be adjusted by means of the nut visible when the plastic nut is removed.

- Turn the Spool until the free end of the electrode is accessible. While securely holding the electrode, cut off the bent end and straighten the first six inches. (If the electrode is not properly straightened, it may not feed properly through the wire drive system. Manually feed the wire from the wire reel and through the wire guide and then over the top of the wire feed rollers (ensure the pressure arms are in the raised position).
- Continue to feed the wire through the outlet guide until 20mm of wire is protruding from the front of the machine torch connector.
- Re-position the adjustable pressure arms to their original position to apply pressure. Adjust pressure as necessary.

NOTE: The pressure arm should be adjusted to give the minimum amount of pressure on the wire to allow reliable feeding.

5.11 Torch Installation

- Insert the Euro connector of the welding torch into the Euro socket and screw tight with the hand nut.
- Fit the coolant hoses to the appropriate quick couplings: red (coolant back flow) and blue (coolant supply).

Wire feed

Opening the door of the wire feeder drive

CAUTION

The door of the feed system must be opened for the following operations. The door must be closed again before starting work.

Loading the wire to the feed unit

CAUTION Risk of injury due to moving parts!

Wire feeders are equipped with moving parts that can trap hands, hair, clothes or tools and thus injure people!

- Do not handle rotating or moving parts or drive parts by hand!
- Keep the protective covers closed during operation! Risk of injury due to uncontrolled welding wire!

The welding wire can be feeding at high speed and can get out of control and injure people in the case of improper or incomplete wire feeding!

- Ensure full wire delivery from the wire coil to the welding torch before connecting to the mains!
- If the welding torch is not installed, unscrew the rollers of the wire feeder!
- Check the wire delivery at regular intervals!
- Keep all body covers and protective covers closed during operation!

Risk of injury due to welding wire feeding from the welding torch!

The welding wire can overflow the welding torch with a high speed and injure face and eyes with body parts!

- Never point the welding torch to your body and to the bodies of others!

ATTENTION

The wear on the wire feed rollers increases due to unsuitable roller pressure!

- In the setting nuts of the pressurised pressure units, it must be adjusted so that the wire electrode is stopped, but only when the wire feed is blocked!
- Adjust the press pressure of the front rollers (when viewed in the push direction) higher!
- The transmission speed can be infinitely adjustable by pressing the wire feed button and by rotating the wire feed speed rotary knob. The selected feed rate is shown on the left display of the wire feed unit.
- Extend the torch straight while loading wire.

Your MasterWeld MIG/MAG Welding Torch has been supplied ready to weld. It has been supplied with the standard consumables denoted in the product brochure.

To connect the torch to the power source:

1. Remove the tip adaptor and contact tip
2. Inch the wire from the exit of the wire guide on the feed unit as Figure 1. Ensure that it does not short out on any machine panels.

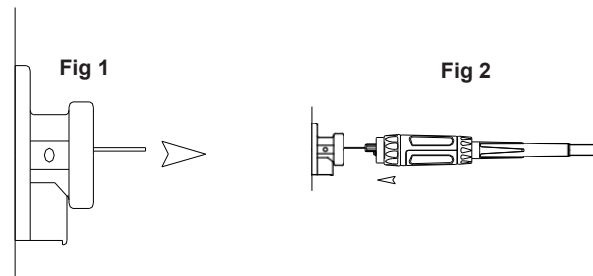

3. Carefully slide the electrode wire into the torch liner and slowly locate the torch gun plug body into the feed unit central connector and tighten the gun plug nut as Figure 2

NOTE: To aid the initial location of a new torch and to prevent damage to the gas nipple O Ring a very light application of grease to the O Ring is beneficial.

4. Keeping the torch as straight as possible, use the power source inch facility or torch trigger to feed the electrode wire 50mm from the end of the liner conduit.
5. once the electrode wire has stopped, refit the tip adaptor, diffuser, contact tip and gas nozzle.
6. Trim the electrode wire to within 5mm of the face of the nozzle, this will facilitate jolt free arc initiation.
7. Press the gas purge button and check the gas flow is adequate for your application.
8. An inexpensive flow meter is available from MasterWeld
9. If you are setting a water-cooled torch, ensure you have the recommended water flow rate.

NOTE: it is essential to ensure adequate low of clean, cool water to prevent irreparable torch failure, a minimum of 1.2 l/min is recommended.

Note. Water flows into the torch through the blue hose. The blue hose delivers cold water directly to the prime source of heat, the swan neck and consumable. The re circulated water is then passed through the torch power cable to cool the power cable as it is returned to the cooler through the red water return lead.

Ensure all air is removed from the water-cooling circuit before welding.

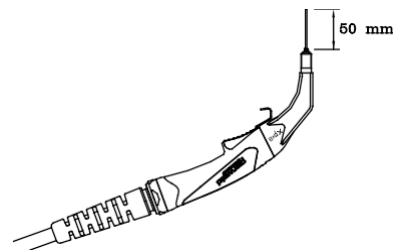

5.12 Work Return Lead Connection

Insert the work return lead connector into the receptacle on the front panel of the machine and twist it clockwise until tightly secured.

Connect the earth clamp to the work piece as close as possible to the point to be welded and ensure that a good electrical connection is created to bare metal.

5.13 Shielding Gas Connection

1. Using the gas hose supplied connect the hose to the gas inlet connection on the rear of the machine and tighten it with a spanner.
2. Connect the opposite end of the gas hose to the output connection of a gas regulator capable of supplying the correct gas flow for the welding operation.

NOTE: If the gas cylinder is to be stored on the back of the machine ensure it is secured using the retention chain provided.

6.0 Operation

Switch on the machine using the mains on/off switch, this lights the front panel.

You can MIG weld in 2 modes Manual and Synergic the manual mode takes more skill to setup.

Synergic MIG

- Select the Synergic MIG mode using button

6.1 Operation Selecting the JOB

Press and hold JOB button for 5 seconds (7) until the left display says JOB rotate the right-hand knob until the correct JOB number is displayed. Refer to the inside of the wire feeder door for job list.

Note Job list is shorter with Rapid panel, and you should select material and wire size on the front panel using buttons 10 and 11.

Adjusting the Function. Press and hold the F button (3) for 5 seconds and the left display will show the F number which can be adjusted by rotating the left knob 4 and the value will be displayed in the right display and can be adjusted with the right-hand knob.

Press the F button (3) briefly to display wire speed, material thickness or Amperage depending on your preference and then rotate the left knob (4) until you reach the required value. You are ready to weld, if you prefer to alter the welding voltage you can trim it up or down by rotating the right knob (8) and the V+/- light will illuminate.

Switch off the synergic light or with Rapid panel toggle off the using F function.

Manually adjust the Wire speed and welding voltage using the rotary knobs 4 and 8. Note in manual mode you must adjust the voltage to increase or reduce penetration and the wire speed to balance the heat input. (Synergic mode is preferred for operation in all operations)

6.2 Operation (2T)

Select 2T operation on the front panel.

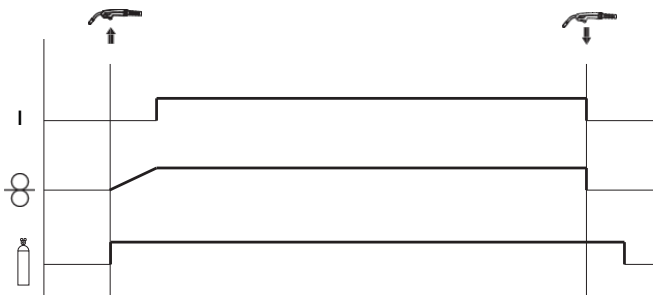

- Depress the trigger and hold on.
- Pre-gas will start (adjust with F30)
- Then arc will start
- At the end of the weld release the trigger and the arc stops.
- The wire stick out can be adjusted by changing burn back time (F41)
- The post gas low can be adjusted as required (F43)

6.3 Operation (4T)

Select 4T operation on the front panel

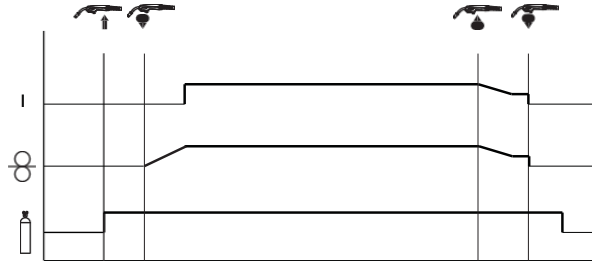

- Depress the trigger and hold
- Pre-gas will start and stay on
- Release the trigger the arc will start and continue
- At the end of the weld depress and hold the trigger, the final current will start (F39) and will stay on until the trigger is released which starts post gas (F43)

6.4 Operation (S4T)

Select 4T operation on the front panel

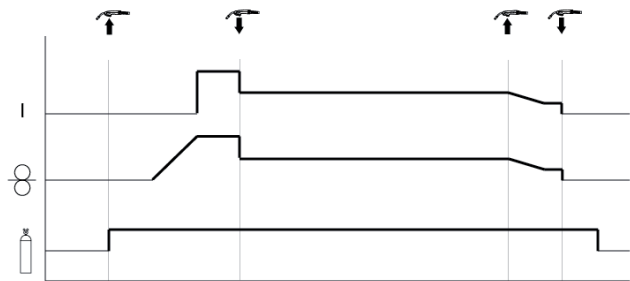

- Depress the trigger and hold
- Pre-gas will start and stay on (F30)
- Hot start current will start (F32)
- Release the trigger the arc will change to the normal power level and continues
- At the end of the weld depress and hold the trigger, the final current will start (F39) and will stay on until the trigger is released which starts post gas (F43)

6.5 Operation Smart Trigger

Smart trigger allows the user to change memory programs quickly from the torch without having to return to the machine. Store the required programs starting at memory location 01, 02 etc.

Using F47 set the number of memories you wish to use for smart trigger. If you wish to use 4 different settings in memory 01, 02, 03 and 04 then set F47 value to 04 and smart trigger will only cycle through memory 01 to 04.

Ensure the front panel of the machine is set to 4T or S4T operation. Set the value of F46 to 01 to switch on smart trigger.

Now if you give the trigger a short press (less than 1 second) it will select the next memory program within the limit set by F47. Another short press moves to the next memory location etc.

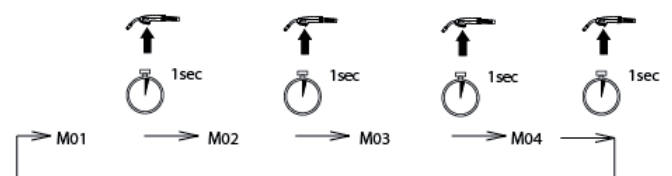

6.6 MIG Operation

Note: Check that drive rolls, and torch parts are correct for the wire size and type being used.

1. The optimum idle roll pressure varies with type of wire, wire diameter, surface conditions, lubrication, and hardness. As a general rule, hard wires may require greater pressure, and soft, or aluminium wire, may require less pressure than the factory setting. The optimum idle roll setting can be determined as follows:
2. Press end of gun against a solid object that is electrically isolated from the welder output and press the gun trigger for several seconds.
3. If the wire "bird nests", jams or breaks at the drive roll, the idle roll pressure is too great. Back the adjustment knobs out 1/2 turn, run new wire. If the only result was drive roll slippage, loosen the Hand nut on the central connector and pull the gun forward about 6" (15cm) away from the power source. There should be a slight waviness in the exposed wire. If there is not waviness, the pressure is too low. Tighten the adjustment knob 1/4 turn, reinstall the gun cable and repeat the above steps.
4. When triggering, the electrode and drive mechanism are electrically "LIVE" relative to work and ground and remain "LIVE" several seconds after the gun trigger is released.

WARNING

When using an open arc process, it is necessary to use correct eye, head, and body protection.

5. Position wire over joint. The end of the wire may be lightly touching the work.
6. Lower welding helmet, operate gun trigger, and begin welding. Hold the gun so the contact tip to work distance is about 3/8" (10mm).
7. To stop welding, release the gun trigger and then pull the gun away from the work after the arc goes out.
8. When no more welding is to be done, close valve on gas cylinder (if used), momentarily operate gun trigger to release gas pressure and turn off the machine.

NOTE: These settings are guidelines only. Material and wire type, joint design, fit up, position, shielding gas, etc. affect settings. Produce test welds to be sure they comply to specifications.

Welding circuit calibration.

The welding circuit resistance can vary, but the machine can be set to compensate for this. Cut the welding wire flush with the front of the contact tip and remove the outer nozzle. Select F60 from the function menu while holding the contact tip firmly against the work piece. Press the trigger three to five times for approximately 1 second to calibrate the circuit resistance. The correction figure will be shown in the PH display (millivolts).

Material thickness determines weld parameters.

1. Convert Material Thickness to Amperage (A) (0.25mm= 1Amp)
3.2mm = 125 A
 2. Select Wire Size
- | Amperage Range | Wire Size |
|----------------|-----------|
| 40 - 145 A | 0.8 mm |
| 50 - 180 A | 1.0 mm |
| 75 - 250 A | 1.2 mm |

3. Select Wire Speed (Amperage)

Wire Size	Feed speed
0.8 mm	0.05m/min per Amp
1.0 mm	0.04m/min per Amp
1.2 mm	0.025m/min per Amp

So based on 3.2 mm material thickness amperage should be 125A if using 1.0mm wire then the wire feed speed should be
0.04 X 125= 5m/min

Wire speed (amperage) controls weld penetration

4. Select Voltage. Voltage controls height and width of weld bead

Low Voltage: wire stubs into work

High Voltage: arc is unstable (spatter)

Set voltage midway between high/low voltages.

And then fine tune accordingly

6.7 MMA Welding

Output Polarity Connections

Electrode polarity

MMA electrodes are generally connected to the '+' terminal and the work lead to the '-' terminal.

The twist connector on the wire feeder is a + outlet.

But if in doubt consult the electrode manufacturer's literature.

MMA Welding Operation

WARNING

When using an open arc process, it is necessary to use correct eye, head, and body protection.

MMA Welding Guide

Select JOB 7 and the left display will show the amperage and the right display will show EL. You can adjust the welding amperage using the left-hand knob (4) you can alter the MMA Arc force, Hot start, Arc Force. Using F70, F71, F72.

Effects of MMA welding various materials

High tensile and alloy steels

The two most prominent effects of welding these steels are the formation of a hardened zone in the weld area, and, if suitable precautions are not taken, the occurrence in this zone of under-bead cracks. Hardened zone and under-bead cracks in the weld area may be reduced by using the correct electrodes, preheating, using higher current settings, using larger electrode sizes, short runs for larger electrode deposits or tempering in a furnace.

Manganese steels

The effect on manganese steel of slow cooling from high temperatures is embrittlement. For this reason, it is essential to keep manganese steel cool during welding by quenching after each weld or skip welding to distribute the heat.

Cast iron

Most types of cast iron, except white iron, are weldable. White iron, because of its extreme brittleness, generally cracks when attempts are made to weld it. Trouble may also be experienced when welding white-heart malleable, due to the porosity caused by gas held in this

type of iron.

Copper and alloys

The most important factor is the high rate of heat conductivity of copper, making preheating of heavy sections necessary to give proper fusion of weld and base metal.

Types of electrodes

Arc welding electrodes are classified into several groups depending on their applications. There are a great number of electrodes used for specialised industrial purposes which are not of particular interest for everyday general work. These include some low hydrogen types for high tensile steel, cellulose types for welding large diameter pipes, etc. The range of electrodes dealt with in this publication will cover the vast majority of applications likely to be encountered; are all easy to use and all will work on even the most basic of welding machines.

Metals Being Joined and Electrode Comments

Mild steel

6013 ideal electrodes for all general-purpose work. Features include outstanding operator appeal, easy arc starting and low spatter.

Mild steel

7014 all positional electrode for use on mild and galvanised steel furniture, plates, fences, gates, pipes and tanks etc. Especially suitable for vertical down welding.

Cast iron

99% nickel suitable for joining all cast irons except white cast iron

Stainless steel

318L-16 high corrosion resistance. Ideal for dairy work, etc.

On stainless steels vertical, lift the torch up from the work piece to draw out an arc. To prevent melting of the end of the tungsten so this in a smooth rapid movement

TIG welding guide ranges.

6.8 Basic TIG Welding Guide

TIG welding cable connection

Connect the TIG torch to the - terminal and the work lead to the + terminal for direct current straight polarity. Direct current straight polarity is the most widely used polarity for DC TIG welding. It allows limited wear of the electrode since 70% of the heat is concentrated at the work piece. Connect the gas hose on the TIG torch to the gas outlet on the gas regulator. Move the selector switch on the front panel of the machine to the LIFT-TIG position.

Torch starting in LIFT-TIG mode

To operate in TIG welding mode select JOB 6 on the right control and the left display will show amperage and the right display will show TIG. You can adjust the welding amperage with the left control.

Ensure the gas supply is switched on and gas is flowing from the front of the torch nozzle. Briefly contact the tip of the tungsten electrode down onto the work piece with the torch at around 70° from vertical, lift the torch up from the work piece to draw out an arc. To prevent melting of the end of the tungsten so this in a smooth rapid movement.

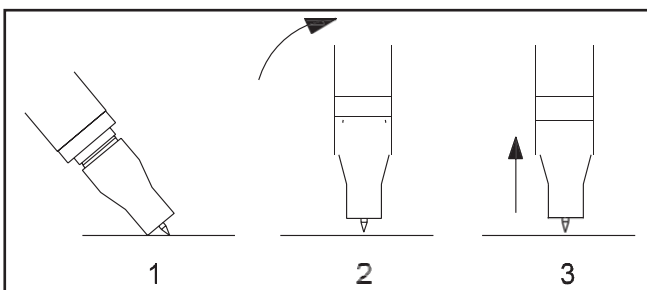

6.9 Additional Functions

6.9.1 Memory function

RAPID panel has 3 memory location available which can be selected using button 5

PRO panel has up to 100 memory locations available. The number of memory locations available to the use can be set.

Auto save is enabled by default and after adjusting any of the parameters the memory display will flash to show it is saved.

Altering the number of memory locations available (PRO panel). Press and hold the F button for 5 seconds. Select F45 and increase or decrease the number of memory locations to suit the user.

Switching off Auto Save. Press and hold the F button for 5 seconds. Select F44 and set the value to zero. With auto save off it is now required to press and hold the down button (5) until the memory display goes out which confirms the save. You can switch on Auto save again by setting the value of F44 to 01.

6.9.2 Supervisor Lock

It is possible to set the machine in lock mode so that the operator can only use JOBS that have been saved to memory. To activate the lock function first program the machine as required for the user and then follow the following steps to activate the lock.

Switch off the machine press the mem down arrow (5) and hold while switching on the machine until you see LOC on the display and then rotate the right-hand knob, so the value is 01 (On). It will now not be possible to adjust any parameter other than the memory location and the voltage trim.

To remove the lock, switch off the machine press the mem down arrow (5) and hold while switching on the machine until you see LOC on the display and then rotate the right-hand knob, so the value is 00 (Off).

6.9.3 Pulse Balance Adjustment

The standard pre-set double pulse function should be suitable for all applications but if you need to change the double pulse parameter you can do so as detailed below

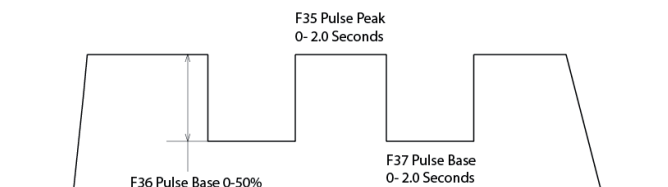

Using the F functions F35, F36, F37 and F38

F35 is the time spent and the peak (normal) power level and can be adjusted from 0 to 2.0 Seconds. Increasing this parameter will give increased heat input and a wider spread of the weld pool.

F36 is the difference between the normal power level and the low power level. It can be adjusted from 0 to 50% at 50% the low power level will be 50% less than the normal power level.

F37 is the time spent and the base (low) power level and can be adjusted from 0 to 2.0 Seconds. Increasing this parameter will give reduced heat input

F38 is the voltage trim for the base current level and can be adjusted +/- 0 to 9.9 volts

TIG Welding Guide Ranges

Electrode diameter	DC current (amps)
0.040" (1.0mm)	30 – 60
1/16" (1.6mm)	60 – 115
3/32" (2.4mm)	100 – 165

Tungsten Electrode Types

Electrode type	Welding application	Colour code
Thoriated 2%	DC welding of mild steel, stainless steel and copper. Excellent arc starting, long life, high current carrying capacity.	RED
Ceriated 2%	DC welding of mild steel, stainless steel, copper, aluminium, their alloys longer life, more stable arc, easier starting, wider current range, narrower more concentrated arc	GREY

Guide for Selecting Filler Wire Diameter

Filler wire diameter	DC current range
1/16" (1.6 mm)	20 - 90
3/32" (2.4 mm)	65 - 115
1/8" (3.2 mm)	100 - 165
3/16" (4.8 mm)	200 - 350

The filler wire diameter specified is a guide only, other diameter wires may be used according to the welding application.

Shielding Gas Selection

Alloy	Shielding gas
Aluminium & alloys	Pure Argon
Carbon steel	Pure Argon
Stainless steel	Pure Argon
Nickel alloy	Pure Argon
Copper	Pure Argon
Titanium	Pure Argon

Function Table					
	Function	Description	Min	Max	Unit
MIG/MAG	F30	Pregas	0	5.0	Seconds
	F31	Soft Feeding On / Off	0	1	Off / On
	F41	Burn Back	0	15	Range
	F42	Wire Cutting	0	15	Range
	F43	Post Gas	0	5.0	Seconds
MMA	F25	Hot Start	100	350	%
	F26	Hot Start Time	0	2	Seconds
	F27	Arc Force	0	400	%
TIG	F10	Water Cooling Unit	0	1	Off/On
		Application	Job		
		MIG Manual	5		
		TIG WIG	6		
		MMA Electrode	7		
	MT	Material Thickness			
	WD	Wire Diameter			
	WS	Wire Speed			

Welding Parameters (SG2/3 G3/4 Si1)					
MK (mm)	WD	Ar-82 / CO2-18		CO2-100	
		MT	VOLT	MT	VOLT
0.8	0.8	2.0	15.1	2.0	15.7
	1.0	1.5	15.1	1.8	17.4
1.0	0.8	2.6	15.4	2.7	16.3
	1.0	2.2	15.4	2.1	17.8
	1.2	1.2	14.4	1.6	17.8
2.0	0.8	5.5	17.4	4.8	19.0
	1.0	4.0	18.0	3.2	18.7
	1.2	3.2	17.1	2.8	18.7
3.0	0.8	8.8	19.2	9.2	26.5
	1.0	5.1	18.7	4.6	19.9
	1.2	4.3	18.7	3.6	19.6
4.0	0.8	10.8	20.8	12.0	28.9
	1.0	7.0	19.8	6.3	21.7
	1.2	5.0	19.8	4.9	21.7
5.0	0.8	14.0	21.9	14.2	30.9
	1.0	8.5	21.4	8.2	27.1
	1.2	6.2	20.5	6.1	24.3
6.0	0.8	17.8	23.2	18.6	32.7
	1.0	9.8	24.7	9.5	29.1
	1.2	7.8	26.1	7.3	29.7
8.0	0.8	22.0	27.1	21.8	34.8
	1.0	12.0	28.8	11.6	31.8
	1.2	8.5	28.0	9.1	31.8
10.0	1.0	14.8	30.6	14.2	34.9
	1.2	9.8	29.7	11.3	33.7

7.0 Fault Finding

Problem	Cause/Corrective Action
Porosity - small cavities or holes. Resulting from gas pockets in weld metal.	<p>Inadequate shielding gas coverage. Check for proper gas flow rate.</p> <p>Remove spatter from gun nozzle.</p> <p>Check gas hoses for leaks.</p> <p>Eliminate drafts near welding arc.</p> <p>Place nozzle 6-13 mm from work piece Hold gun near bead at end of weld until molten metal solidifies.</p> <p>Wrong gas. Use welding grade shielding gas; change to different gas.</p> <p>Dirty welding wire. Use clean, dry welding wire. Eliminate pickup of oil or lubricant on welding wire from feeder or liner.</p> <p>Work piece dirty. Remove all grease, oil, moisture, rust, paint, coatings, and dirt from work surface before welding. Use a more highly deoxidizing welding wire (contact supplier).</p> <p>Welding wire extends too far out of nozzle.</p> <p>Be sure welding wire extends not more than 13 mm beyond nozzle.</p>

Problem	Cause/Corrective Action
Incomplete fusion to base metal.	<p>Work piece dirty. Remove all grease, oil, moisture, rust, paint, coatings, and dirt from work surface before welding.</p> <p>Insufficient heat input. Select higher voltage range and/or adjust wire feed speed.</p> <p>Improper welding technique. Place stringer bead in proper locations) at joint during welding.</p> <p>Adjust work angle or widen groove to access bottom during welding.</p> <p>Momentarily hold arc on groove side walls when using weaving technique.</p> <p>Keep arc on leading edge of weld puddle. Use correct gun angle of 0 to 15 degrees.</p>
Excessive Penetration – weld metal melting through base metal and hanging underneath weld.	<p>Excessive heat input. Select lower voltage range and reduce wire feed speed.</p> <p>Increase travel speed.</p>
Lack Of Penetration - shallow. Fusion between weld metal and Base metal.	<p>Improper joint preparation. Material too thick. Joint preparation and design must provide access to bottom of groove while maintaining. Proper welding wire extension and arc characteristics.</p> <p>Improper weld technique. Maintain normal gun angle of 0 to 15 degrees to achieve maximum penetration. Keep arc on leading edge of weld puddle. Ensure welding wire extends not more than 13 mm beyond nozzle.</p> <p>Insufficient heat input. Select higher wire feed speed and/or select higher voltage range. Reduce travel speed.</p>
Burn-Through - weld metal melting. Completely through base metal. Resulting in holes where no metal remains.	<p>Excessive heat input. Select lower voltage range and reduce wire feed speed.</p> <p>Increase and/or maintain steady travel speed.</p>

Problem	Cause/Corrective Action
Excessive Spatter - scattering of Molten metal particles that cool to solid form near weld bead.	<p>Wire feed speed too high. Select lower wire feed speed.</p> <p>Voltage too high. Select lower voltage range.</p> <p>Electrode extension (stick out) too long. Use shorter electrode extension (stick out).</p> <p>Work piece dirty. Remove all grease, oil, moisture, rust, paint, undercoating, and dirt from work surface before welding.</p> <p>Insufficient shielding gas at welding arc. Increase flow of shielding gas at regulator/flow meter and/or prevent drafts near welding arc.</p> <p>Dirty welding wire. Use clean, dry welding wire. Eliminate pickup of oil or lubricant on welding wire from feeder or</p>
Wire feed unit operates but no gas flow.	<p>Gas cylinder empty.</p> <p>Gas regulator closed.</p> <p>Faulty solenoid.</p> <p>Restriction in torch cables.</p>
Wire feed unit operates but does not feed.	<p>Insufficient drive roll pressure.</p> <p>Incorrect drive rolls.</p> <p>Excessive wire spool brake tension.</p> <p>Incorrect liner.</p> <p>Blocked liner.</p> <p>Bird nesting.</p> <p>Burn back.</p>
Bird nesting.	<p>Excessive feed roll pressure.</p> <p>Incorrect or blocked liner.</p> <p>Incorrect contact tip size.</p> <p>Contact tip overheating.</p> <p>Restriction in torch cable.</p> <p>Misaligned drive rolls or wire guides.</p> <p>Excessive cable kinkage.</p>
Burn back.	<p>Improper voltage setting.</p> <p>Improper stick out.</p> <p>Erratic wire feed.</p> <p>Incorrect or blocked liner.</p> <p>Contact tip overheating.</p> <p>Excessive cable kinking.</p>

Problem	Cause/Corrective Action
Erratic Wire Feeding or Arc.	<p>Improper drive roll tension.</p> <p>Improper drive roll size.</p> <p>Worn drive rolls.</p> <p>Incorrect or blocked liner.</p> <p>Incorrect wire guide size.</p> <p>Misaligned drive rolls or wire guide.</p> <p>Gaps at liner or wire guide junctions.</p> <p>Incorrect contact tip size.</p> <p>Contact Tip overheating.</p> <p>Spatter adhesion on exit geometry of tip bore.</p> <p>Excessive cable kinkage.</p> <p>Poor earth or cable connections.</p> <p>Weld joint area dirty.</p>
Yellow temperature light illuminates.	<p>Power source has over heated leave the machine running to allow it to cool down.</p> <p>Ensure entry and exit vents on machine are clear and machine has a good supply of cooling air.</p> <p>Reduce operating duty cycle and or amperage.</p>

7.1 Repair and Maintenance

DANGER Improper maintenance and use!

The machine may only be cleaned, repaired or controlled by qualified, trained persons!

The competent person is the person who knows the dangers and potential damages that occur in these machines through their training, knowledge and experience and can take the necessary safety measures.

- Perform all checks in the following section!
- Restart the machine only after successful maintenance.

Risk of injury from electric shock!

Work on machines not disconnected from the electrical supply can cause serious injury!

- Safely disconnect the machine from the electrical supply.
- Disconnect the mains connector!
- Wait 4 minutes until the condensers are empty!

Repair and maintenance work must only be carried out by trained and authorised specialist personnel, otherwise the warranty is void. Contact your authorised dealer or the supplier of the device for any service issues. Refunds for warranty claims can only be made through your authorised dealer. Only original spare parts should be used for parts replacement. When ordering spare parts, the machine type, serial number and model number of the machine, type identification and product number of the spare part must be specified.

General

This device is largely maintenance-free and requires minimal cleaning under normal operating conditions. In order to ensure that the welding machine operates flawlessly, it is still necessary to pay attention to some points. This includes regular cleaning and maintenance of the welding machine depending on the degree of contamination from the environment and the duration of the welding machine.

Maintenance intervals

Daily Maintenance

- Check that all connections and moving parts are secure, tighten if necessary.
- Wire feed rollers must be cleaned regularly

Visual control

- Check the hose package and the power connections for external damage and replace if necessary or have them repaired by qualified personnel!
- Main power supply and connection plug
- Gas hoses

Operation checks

- Check that the wire coil is properly fixed.
- Welding cables check firm, locked position
- Gas cylinder regulators and securing straps

Monthly maintenance work

Visual control

- Body damage (front, rear and side walls)
- Wheels security and operation
- Check the coolant hoses and their connections for leaks

Operation control

- Check Selector switches, power isolators, voltage reduction devices, warning and control lamps
- Check whether the wire feed elements are secure

Annual inspections (inspection and inspection during operation)

Inspection of the welding machine may only be carried out by qualified and authorised persons. The expert is the person who knows the hazards and potential damages in the source power sources with their education, knowledge and experience and can take the necessary security measures.

7.2 Error Codes

Resetting All errors Press F (button 3) on the front panel until the memory display shows 10.

Error Code	POSSIBLE CAUSES	SOLUTION
E1	Input Phase Failure	Check input voltage and wires inform the authorised service if there are any problems.
E4	Transformer Thermal Error	Ensure that the Power Unit Fan is operating. Wait 15-20 minutes without welding (machine on). If the problem persists, notify the Authorised Service centre.
E5	IGBT Thermic Error	Ensure that the Power Unit Fan is operating. Wait 15-20 minutes without welding (machine on). If the problem persists, notify the Authorised Service.
E6	Diode Thermal Error	Ensure that the Power Unit Fan is operating. Wait 15-20 minutes without welding (machine on). If the problem persists, notify the Authorised Service.
E8	E8 Front panel Card Data Receive Error	Front Panel Board Cannot Communicate with Motor Card. Check Socket and Cables. If the problem persists, notify the Authorised Service.
E9	Motor Card Receiving Data Error	Check Sockets and Cables Between Motor Board and Front Panel Board.
		Check Communication Cable Between Intermediate Hose Package and Wire Feeding Unit.
E10	Control card Receiving Data Error	The Control Card in the power unit cannot receive data. Check the Voltage and Ports of the cables.
		Check Communication Cable Between Intermediate Hose Package and Wire Feeding Unit.
E12	High Current Error Protection	Check between the + and - poles of your machine to ensure no short circuit.
E14	High Current Error Protection	Make a short circuit check between the + and - poles of your machine.

8.0 Accessories

8.1 Gas Equipment

Everyday Gas Regulators –
300 BAR

Single Stage

Features

Flow rate up to 96m³/h (3389 ft³/h)

- Full 300 bar capability
- Outlet pressure indicated on the bonnet
- Bottom entry design suited for top outlet cylinder valves

Fittings

- Fitted with standard 3/8" BSP outlet
- Fitted with 5/8" BSP inlet connections

Max. Outlet Pressure

3.0 Bar



8.2 Feed Rolls

Part No	Description	Application
DR7V0810	D/ROLL 0.8-1.0 V GROOVE	0.8-1.0 Hard Wires
DR7V1012	D/ROLL 1.0-1.2 V GROOVE	1.0-1.2 Hard wires
DR7V1216	D/ROLL 1.2-1.6 V GROOVE	1.2-1.6 Hard wires
DR7U0810	D/ROLL 0.8-1.0 U GROOVE	0.8-1.0 Soft wire
DR7U1012	D/ROLL 1.0-1.2 U GROOVE	1.0-1.2 Soft wire
DR7U1216	D/ROLL 1.2-1.6 U GROOVE	1.2-1.6 Soft wire
DR7K1216	D/ROLL 1.2-1.6 K GROOVE- F/COR	1.2-1.6 Cored wire
DR7K2428	D/ROLL 2.4-2.8 K GROOVE- F/COR	2.4-2.8 Cored wire

9.0 EC Declaration of Conformity

Hereby we declare that the machines as stated below

Type: MasterWeld KM 501 M-Power Water-Cooled

Conform to the EC Directives:

Low Voltage Directive 2014/35/EEC

EMC Directive 2014/35/EEC

Harmonised European standard: EN/IEC 60974-1

This is to certify that the tested sample is in conformity with all provisions of the above detailed EU directives and product standards.



9.1 RoHS Compliance Declaration

Directive 2011/65/EU of the European Parliament

Amended 2015/863 and 2017/2102

Restriction of use of certain hazardous substances in electrical and electronic equipment

Type: MasterWeld KM 501 M-Power Water-Cooled

The above listed products are certified to be compliant with the RoHS directive with all homogeneous component parts being controlled to ensure material contents as per the list below.

Cadmium 0.01% by weight

Lead 0.1% by weight

Mercury 0.1% by weight

Hexavalent chromium 0.1% by weight

Polybrominated biphenyl's (pbbs) 0.1% by weight

Polybrominated diphenyl ethers (pbdes) 0.1% by weight

it should be noted that under specific exempted applications, where lead is used as an alloying element the following limits are applied in accordance with the regulations.

Copper and copper alloy parts use less than 4% by weight of each homogeneous component.

Steel and steel alloy parts use less than 4% by weight of each homogeneous component.

Aluminium and aluminium alloy parts use less than 4% by weight of each homogeneous component.

Only dispose off in authorised sites for electrical and electronic waste do not dispose of with general refuse or landfill waste.

9.2 WEEE Statement

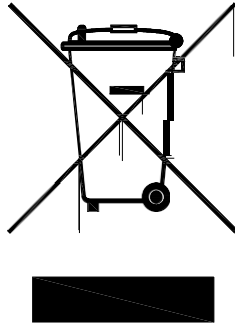

WEEE (Waste Electrical & Electronic Equipment) 2012/19/EU

In relation to implementing the legislation, MasterWeld has established relevant recycling and recovery methods. We have been fully compliant against the marking requirements since August 2005. MasterWeld is registered in the UK with the Environment agency as detailed below. For WEE compliance outside the UK please contact your supplier/Importer.

MasterWeld is registered with a compliance scheme Official registration number is WEE/FD0255QV

When your equipment reaches the end of its service life you should return it to MasterWeld where it will be reconditioned or processed for recycling.

9.3 Statement of Warranty

Limited Warranty:

MasterWeld, hereafter, "MasterWeld" warrants its customers that its products will be free of defects in workmanship or material. Should any failure to conform to this warranty appear within the time period applicable to the MasterWeld products as stated below, MasterWeld shall, upon notification thereof and substantiation that the product has been stored, installed, operated, and maintained in accordance with MasterWeld's specifications, instructions, recommendations and recognised standard industry practice, and not subject to misuse, repair, neglect, alteration, or accident, correct such defects by suitable repair or replacement, at MasterWeld's sole option, of any components or parts of the product determined by MasterWeld to be defective.

MasterWeld makes no other warranty, express or implied. This warranty is exclusive and in lieu of all others, including, but not limited to any warranty of merchant ability or fitness for any particular purpose.

Limitation of Liability:

MasterWeld shall not under any circumstances be liable for special, indirect or consequential damages, such as, but not limited to, lost profits and business interruption. The remedies of the purchaser set forth herein are exclusive and the liability of MasterWeld with respect to any contract, or anything done in connection therewith such as the performance or breach thereof, or from the manufacture, sale, delivery, resale, or use of any goods covered by or furnished by MasterWeld whether arising out of contract, negligence, strict tort, or under any warranty, or otherwise, shall not, except as expressly provided herein, exceed the price of the goods upon which such liability is based. No employee, agent, or representative of MasterWeld is authorised to change this warranty in any way or grant any other warranty.

Purchaser's rights under this warranty are void if replacement parts or accessories are used which in MasterWeld's sole judgement may impair the safety or performance of any MasterWeld product.

Purchaser's rights under this warranty are void if the product is sold to purchaser by non-authorized persons.

The warranty is effective for the time stated below beginning on the date that the authorised Distributor delivers the products to the purchaser. Notwithstanding the foregoing, in no event shall the warranty period extend more than the time stated plus one month from the date MasterWeld delivered the product to the authorised distributor.



MASTERWELD

www.masterweld.co.uk

Importer & Distributor of MasterWeld Products
AES Industrial Supplies Ltd
Olympic House
Collett
Southmead Industrial Park
Didcot
OX11 7WB

www.masterweld.co.uk
orders@aes-sales.com
+44 (0) 1235 510717