

**MW1901**

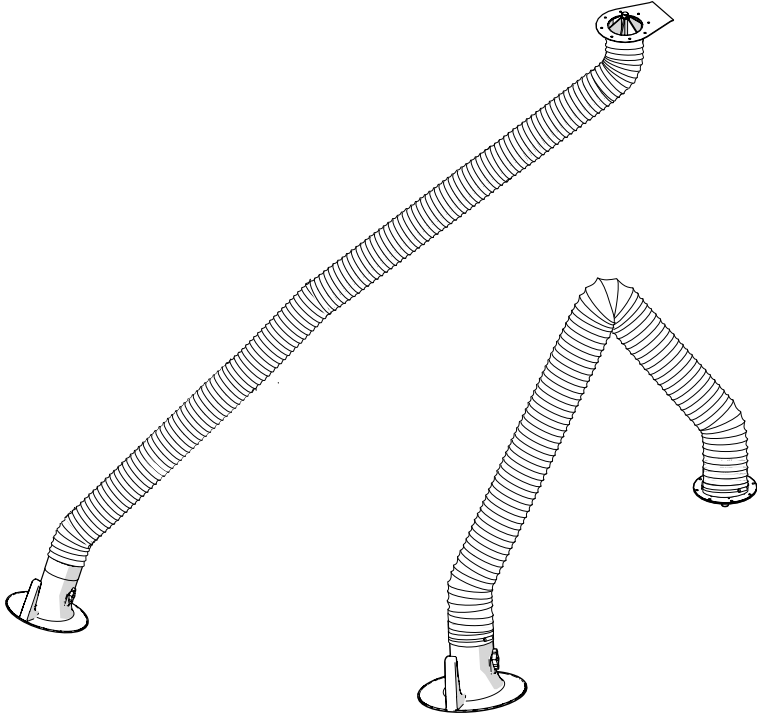

**MASTERWELD**

[www.masterweld.co.uk](http://www.masterweld.co.uk)

<b>1. GENERAL INFORMATION</b> .....	<b>2</b>
1.1. PURPOSE OF THE MANUAL .....	2
1.2. KEY OF SYMBOLS USED .....	2
1.3. DEFINITION OF THE OPERATORS QUALIFICATIONS .....	3
1.4. GLOSSARY .....	3
1.5. ATTACHED DOCUMENTATION .....	4
1.6. WARRANTY .....	4
<b>2. SAFETY INFORMATION</b> .....	<b>4</b>
2.1. RESIDUAL RISKS .....	4
2.2. GENERAL SAFETY WARNINGS .....	4
2.3. SAFETY WARNINGS FOR HANDLING, ASSEMBLY AND INSTALLATION .....	5
2.4. SAFETY WARNINGS FOR INTENDED USE .....	5
2.5. SAFETY WARNINGS FOR ADJUSTMENT/MAINTENANCE .....	5
2.6. SAFETY WARNINGS FOR ENVIRONMENTAL IMPACT .....	5
2.7. SAFETY SIGNS PLACED ON THE MACHINE .....	5
<b>3. HANDLING, ASSEMBLY AND INSTALLATION INFORMATION</b> .....	<b>6</b>
3.1. HANDLING, STORAGE AND PACKAGING .....	6
3.2. ARM ASSEMBLY AND INSTALLATION MODE .....	6
3.3. METHODS FOR INSTALLING OPTIONAL PARTS .....	10
<b>4. TECHNICAL INFORMATION</b> .....	<b>11</b>
4.1. IDENTIFICATION OF THE MANUFACTURER, MACHINE, OR PARTLY-COMPLETED MACHINE .....	11
4.2. DECLARATION OF INCORPORATION OF THE PARTLY COMPLETED MACHINE .....	11
4.3. ARM DESCRIPTION .....	12
4.4. TECHNICAL DATA .....	12
4.4.1. Collection efficiency .....	12
4.4.2. Loss/flow rate curve .....	12
4.5. DESCRIPTION OF PERIMETER AREAS .....	13
<b>5. INFORMATION ON USE</b> .....	<b>15</b>
5.1. RECOMMENDATIONS FOR USAGE .....	15
5.2. INTENDED USE/IMPROPER USE .....	15
5.2.1. Type of treated air .....	15
<b>6. INFORMATION ON ADJUSTMENTS</b> .....	<b>15</b>
6.1. RECOMMENDATIONS FOR ADJUSTMENTS .....	15
6.1.1. Gate adjustment .....	15
6.1.2. Adjusting the joint structure on the fifth wheel side .....	16
6.1.3. Adjusting the central joint structure .....	16
6.1.4. Adjusting the hood joint .....	17
<b>7. MAINTENANCE INFORMATION</b> .....	<b>17</b>
7.1. RECOMMENDATIONS FOR MAINTENANCE INTERVENTIONS .....	17
7.2. TABLE OF SCHEDULED MAINTENANCE INTERVALS .....	17
7.3. CLEANING AND DISPOSAL .....	18
<b>8. INFORMATION ON TROUBLESHOOTING</b> .....	<b>18</b>
<b>9. INFORMATION ON REPLACEMENTS</b> .....	<b>19</b>
9.1. REQUESTING AFTER-SALES ASSISTANCE .....	19
9.2. RECOMMENDATIONS FOR REPLACEMENT INTERVENTIONS .....	20
9.3. LIST OF REPLACEABLE COMPONENTS .....	20
9.3.1. Optional .....	21
9.4. SCRAPPING AND DECOMMISSIONING .....	21



## 1. GENERAL INFORMATION

### 1.1. PURPOSE OF THE MANUAL

The manual has the purpose of providing the machine installer, operator and maintenance technician, the instructions for use, prevention and reduction of risks during man-machine interaction.

OPERATOR	CHAPTERS OF THE MANUAL THAT MUST BE KNOWN
INSTALLER	<ul style="list-style-type: none"> <li>• General information</li> <li>• Safety information</li> <li>• Handling, assembly and installation information</li> <li>• Technical information</li> <li>• Information on replacements</li> </ul>
OPERATOR	<ul style="list-style-type: none"> <li>• General information</li> <li>• Safety information</li> <li>• Information on use</li> </ul>
MAINTENANCE TECHNICIAN	<ul style="list-style-type: none"> <li>• General information</li> <li>• Safety information</li> <li>• Handling, assembly and installation information</li> <li>• Information on use</li> <li>• Information on adjustments</li> <li>• Maintenance information</li> <li>• Information on troubleshooting</li> <li>• Information on replacements</li> </ul>

The information was drawn-up by the Manufacturer in its original language and it can also be made available in other languages, in order to meet the legal and/or business requirements.

The documentation must be kept by the person in charge, in a suitable place, so that it is always available for consultation in the best state of preservation. If lost or worn, request replacement documentation directly from the Manufacturer.

Consult the table of contents to easily locate the specific topics of interest.

Some information may not fully correspond to the effective configuration of the delivered machine.



Any additional information that may be inserted, will not affect legibility and does not jeopardise the safety level.







The Manufacturer reserves the right to change the information without being obliged to notify it in advance, as long as such changes do not alter the safety level.

Any report by the recipients may be an important contribution for the improvement of after-sales services that the Manufacturer intends offering its customers.

Some symbols, the meanings of which are described below, are used to highlight some text or indicate significantly important specifications.

### 1.2. KEY OF SYMBOLS USED

SYMBOL	DESCRIPTION
	<p><b>Danger - Attention</b></p> <p>The symbol indicates situations of serious danger that, if neglected, may place the health and safety of people seriously at risk.</p>
	<p><b>Danger - Attention</b></p> <p>The symbol indicates situations of serious danger that, if neglected, may cause fires and place the health and safety of people seriously at risk.</p>
	<p><b>Caution - Warning</b></p> <p>The symbol indicates the need to adopt adequate behaviour to avoid placing the health and safety of people at risk and not cause economic damages.</p>

SYMBOL	DESCRIPTION
	<b>Important</b> The symbol indicates significantly important technical and operational information that must not be neglected.
	Use protective gloves.
	Use safety footwear.
	Use protective mask.
	Use acoustic protection.
	Use protective eye-wear.
	Use a safety helmet.

### 1.3. DEFINITION OF THE OPERATORS QUALIFICATIONS

Some terms that are frequently used within the manual are described in order to uniquely determine their meaning.

OPERATOR QUALIFICATION	DESCRIPTION
<b>Qualified personnel</b>	Personnel who have attended specialisation, educational and training courses and have experience concerning the installation, commissioning and maintenance of the plants.
<b>Experienced maintenance technician</b>	Technician chosen and authorised from among those having the qualifications, skills and information, to perform routine and extraordinary maintenance interventions.

### 1.4. GLOSSARY

DEFINITION	DESCRIPTION
<b>Hood/Small hood</b>	A rigid element available in various shapes and sizes with the function of receiving polluting elements.
<b>Maintenance</b>	Set of operations required to preserve the functionality and efficiency of the machine. These operations are scheduled by the Manufacturer, who defines the necessary skills and methods of intervention.
<b>Partly-completed machine</b>	An assembly almost constituting a machine but that, on its own, is unable to guarantee a clearly determined application. A drive system is a partly-completed machine. Partly-completed machines are only intended for incorporation or assembly with other machines or with other partly-completed machines or devices to form a machine governed by this directive.

## 1.5. ATTACHED DOCUMENTATION

Below is a list of the documents supplied with the machine and not present inside this manual.

- **EC Declaration of conformity**

## 1.6. WARRANTY

The warranty is **subject to the following general conditions**:

- the packaging must be opened and the installation performed by the Manufacturer's authorised and/or enabled technicians;
- the installed machine commissioning and positive test must be done in the presence and under the supervision of the Manufacturer's technicians or of its agent's; the test report must be filled in.
- the machine must be used within the limits stated in the contract and as indicated in the technical and/or business documentation.
- maintenance must be performed within the time and under the conditions provided by this manual, using original spare parts of **MasterWeld** and entrusting the work to qualified personnel.

The warranty **becomes void** in the event of:

- failure to comply with the safety standards;
- removal or tampering with the control and safety devices (guards, photocells, sensors, micro switches, etc.);
- changes to the safety conditions established by the Manufacturer;
- improper use of the machine;
- use of the machine by untrained and/or unauthorised personnel, or non-compliance with the operators' skills, as specified in the manual;
- changes or repairs made by the user without the Manufacturer's written authorisation;
- partial or total non-compliance with the instruction manual;
- power supply failures (electric power, compressed air, etc.);
- poor maintenance;
- use of non-original spare parts;
- extraordinary events like floods, fires (if not caused by the machines).

The warranty **does not cover**:

- materials such as: oils, cartridges for filters, lubricating grease.
- parts damaged by bad or improper use, by incorrect operator intervention, by unauthorised repair and tampering performed by the customer or by third party, or use of spare parts not supplied by **MasterWeld**.

## 2. SAFETY INFORMATION



**Carefully read the instructions in this manual and those applied directly on the machine.**

### 2.1. RESIDUAL RISKS

RESIDUAL RISK	DESCRIPTION
<b>Danger of crushing upper limbs</b>	Closing mobile elements with cam locks poses the risk of crushing fingers.
<b>Fire risk</b>	Routine operations performed despite the prohibition expressed in paragraph <b>"INTENDED USE/IMPROPER USE"</b> .
<b>Risk of falling</b>	The arm is not equipped with appropriate anchoring elements to perform maintenance activities safely at heights of more than 2 metres.
<b>Risk of accidental opening of the structure during assembly due to the presence of springs</b>	The arm is equipped with safety clamps, which must be cut with the utmost attention during the assembly phase.

### 2.2. GENERAL SAFETY WARNINGS

Personnel performing any type of intervention throughout the lifespan of the partly-completed machine, must have precise technical skills, have particular abilities due to acquired and recognised experience in the specific



sector, be trained on how to use the necessary work tools and appropriate personal protective equipment, with reference to the applicable laws and in force in the place of use of the machine.  
Lacking these requirements may cause damage to people's health and safety.  
Use the personal protective equipment indicated in the manual.

### 2.3. SAFETY WARNINGS FOR HANDLING, ASSEMBLY AND INSTALLATION

Use adequate lifting equipment for handling and adopt all the safety precautions designed for activities carried out in the work site.

The electrostatic charge accumulated by the flexible pipes might ignite a fire. Therefore, they must have electrical conductivity and be earthed.

The maximum allowable tightening values, beyond which the screws lose their mechanical resistance features, are shown in the tables.

The tightening torques must be applied slowly and constantly using a torque wrench. Said values must be decreased by 10% when using impact drivers.

The table refers to class 8.8 screws

DIAMETER PER PITCH	SCREW SECTION mm <sup>2</sup>	SCREW TIGHTENING TORQUES Nm
6 x 1	20	10,4
8 x 1,25	36	25
10 x 1,5	58	50
12 x 1,75	84	87

### 2.4. SAFETY WARNINGS FOR INTENDED USE

The arm was designed to work within the limits prescribed and indicated in the manual.

Using the arm to obtain production levels other than those described in this manual, shall be regarded as "IMPROPER USE".

Carefully read the instructions in paragraph "INTENDED USE/IMPROPER USE".

To be prepared for emergencies, carefully read the instructions in the section titled "INTENDED USE / IMPROPER USE".

### 2.5. SAFETY WARNINGS FOR ADJUSTMENT/MAINTENANCE

Perform routine maintenance as provided for in this manual.

### 2.6. SAFETY WARNINGS FOR ENVIRONMENTAL IMPACT

Before using the machine, operators must be provided with information, instructions and training on the substances the machine is to be used for, including how to safely remove and dispose of the collected pollutant. Do not disperse polluting material in the environment. Perform disposal in compliance with the relative laws in force.

### 2.7. SAFETY SIGNS PLACED ON THE MACHINE

SYMBOL	DESCRIPTION
	<p>The warning adhesive placed on the arm structure near the hoses clamp, which keeps it closed, informs the operator of sudden opening due to the thrust of the springs.</p>

### 3. HANDLING, ASSEMBLY AND INSTALLATION INFORMATION

#### 3.1. HANDLING, STORAGE AND PACKAGING



The standard MasterWeld packaging does not guarantee protection against rain. The machine must be stored in an enclosed environment with a relative humidity below 70%.



The machine must be stored in temperatures between -10°C and +50°C inclusive.



When handling materials, use suitable lifting devices and adopt all of the safety precautions required for the work site activities, also consult the technical data for the packaging described in the Packing List.

#### Packaging:

- in carton boxes for a quantity up to 3 pcs.
- in carton boxes on foot board for 4 pcs and upwards.

MACHINE MODEL	PACKAGING DIMENSIONS (a) x (b) x (h)	WEIGHT (KG)
MASTERWELD160/2 - CARRIAGE	430 x 370 x 370	4,5
	1470 x 220 x 220	9
MASTERWELD160/3 - CARRIAGE	430 x 370 x 370	4,5
	1470 x 220 x 220	10
MASTERWELD160/3 – WALL	430 x 370 x 370	4,5
	1470 x 220 x 220	10
MASTERWELD160/4 – WALL	430 x 370 x 370	4,5
	1860 x 220 x 220	13

The arm comes already assembled and in two carton boxes.

#### 3.2. ARM ASSEMBLY AND INSTALLATION MODE



Before assembly, visually inspect the material to make sure it was not damaged during transportation. If there are signs of damage, inform the seller within 10 days from delivery.

During assembly, installation and maintenance, the screws must be tightened according to the values provided in the table. The tightening torques must be applied slowly and constantly using a torque wrench. Said values must be decreased by 10% when using impact drivers.

The table refers to class 8.8 screws.

DIAMETER PER PITCH	SCREW SECTION mm <sup>2</sup>	SCREW TIGHTENING TORQUES Nm
8 x 1,25	36	10
10 x 1,5	58	10



Before installation, check that the overall dimensions required to perform work and maintenance are without constraint. See paragraph “DESCRIPTION OF PERIMETER AREAS”.



Before proceeding with installation, make sure the wall is able to withstand the overall load of the machine on any optional features. See “TECHNICAL DATA - WEIGHT” and “DESCRIPTION OF PERIMETER AREAS”.

MACHINE MODEL	SUPPORTS
MASTERWELD160/2 - CARRIAGE MASTERWELD160/3 - CARRIAGE	Wheeled suction units
MASTERFLEX160/3 – WALL MASTERFLEX160/4 – WALL	Wall shelf NO-Smoke fan Pedestal Flag





In the version with carriage, the arm must be installed on a MasterWeld wheeled unit.



In the wall version, the arm must be installed on supports and fitted to suction and filtration systems by means of rigid or flexible hoses.



## CARRIAGE version

STEP	ACTION	ILLUSTRATION
1	Place the 8-hole gasket between the surface and fifth wheel. Fasten the fifth wheel with the screws (M8 x 40) and self-locking nuts. Tighten the nuts (7 Nm).	
2	Insert the fifth wheel elastic hoses clamp.	
3	Install the preassembled structure on the fifth wheel with the two screws (M10 x 50) and self-locking nuts.	
4	Insert the small hood elastic hoses clamp.	



**STEP ACTION ILLUSTRATION**

- 5  **Cut the plastic hoses clamp and lay the structure.**

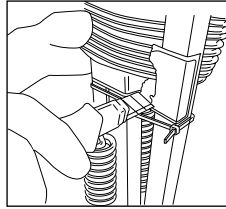

- 6 Mount the small hood on the structure using the preassembled M10 bolt.

- 6  **Keep the friction elements in the correct position.**

See paragraph "LIST OF REPLACEABLE PARTS".

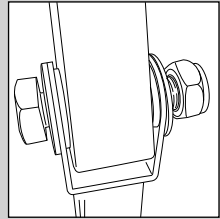
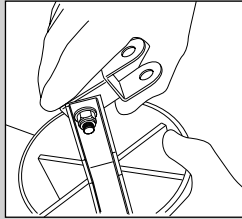

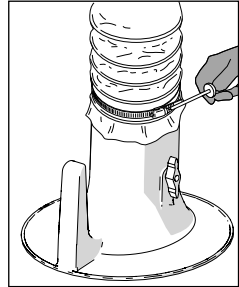
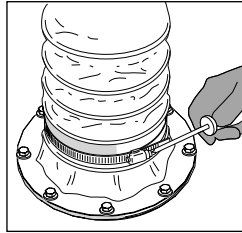

- 7 Stretch the flexible hose along the entire arm structure and secure it to the fifth wheel and then to the small hood with the steel hoses clamp.

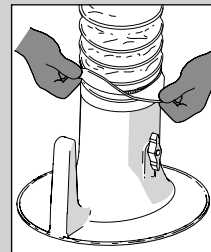
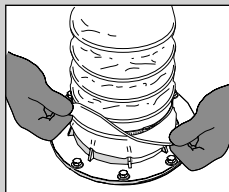

- 8 Place the elastic hoses clamps on the steel hoses clamp.

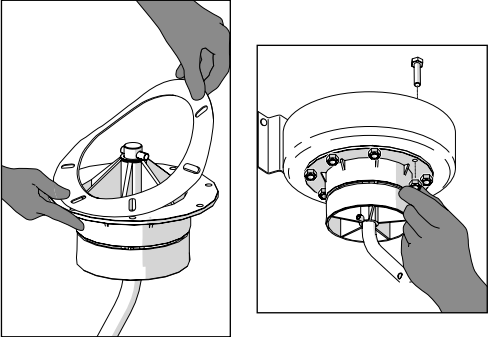
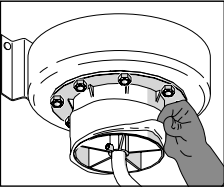
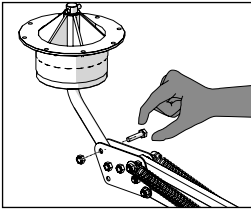
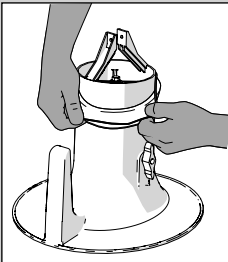

WALL version:

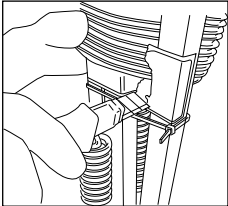
STEP	ACTION	ILLUSTRATION
1	Place the 8-hole gasket between the surface and fifth wheel. Fasten the fifth wheel with the screws (M8 x 40) and self-locking nuts. Tighten the nuts (7 Nm).	
2	Insert the fifth wheel elastic hoses clamp.	
3	Install the preassembled structure on the fifth wheel with the two screws (M10 x 50) and self-locking nuts.	
4	Insert the small hood elastic hoses clamp.	
5	 <b>Cut the plastic hoses clamp and lay the structure.</b>	

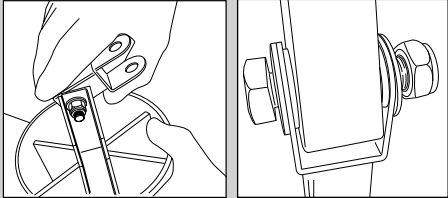
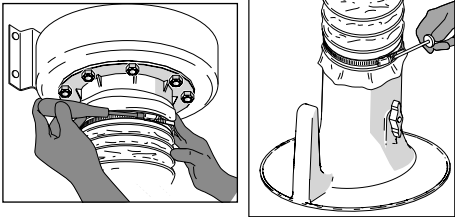
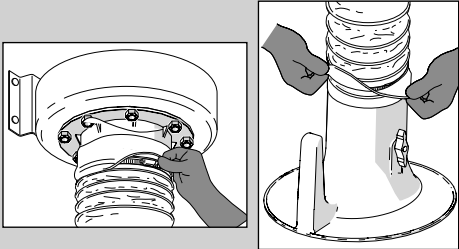
STEP	ACTION	ILLUSTRATION
6	<p>Mount the small hood on the structure using the preassembled M10 bolt.</p> <p> <b>Keep the friction elements in the correct position.</b></p> <p>See paragraph “<b>LIST OF REPLACEABLE PARTS</b>”.</p>	
7	<p>Stretch the flexible hose along the entire arm structure and secure it to the fifth wheel and then to the small hood with the steel hoses clamp.</p>	
8	<p>Place the elastic hoses clamps on the steel hoses clamp.</p>	

### 3.3. METHODS FOR INSTALLING OPTIONAL PARTS



Prior to any installation procedure, read the instructions provided in the “**RECOMMENDATIONS FOR MAINTENANCE INTERVENTIONS**” paragraph carefully.



Optional equipment that is difficult to assemble is not described in this manual. Contact the MasterWeld Technical Office for information.

To replace optional parts, see paragraph “**LIST OF REPLACEABLE PARTS**”.

The following optional parts can be mounted on the machine:

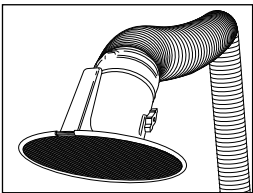

#### **SPARKS STOP NET KIT**

STEP	ACTION	ILLUSTRATION
1	Place the net on the hood end.	
2	Place the gasket on the circumference of the hood with net.	

## 4. TECHNICAL INFORMATION

### 4.1. IDENTIFICATION OF THE MANUFACTURER, MACHINE, OR PARTLY-COMPLETED MACHINE

The manufacturer's identification is found on the declaration of conformity.

### 4.2. DECLARATION OF INCORPORATION OF THE PARTLY COMPLETED MACHINE

#### **Declaration of incorporation of the partly completed machine**

**MasterWeld** declares herein that the partly completed machine complies with annex II, part 1, section B of the Machinery Directive 2006/42/EC and that the technical documentation, as set forth in annex VII B, has been provided. The manufacturer undertakes to provide, upon request from national authorities, information on the partly completed machine. The above-mentioned partly completed machine cannot be commissioned before the machine or system in which it is incorporated is declared compliant with the Machinery Directive 2006/42/EC.

The technical dossier is held by MasterWeld



### 4.3. ARM DESCRIPTION

The arm conveys pollutant agents produced locally towards specific filtration and deodorisation systems, which can run individually if they are equipped with single suction device or can be built into a centralised system.

### 4.4. TECHNICAL DATA

#### 4.4.1. COLLECTION EFFICIENCY

In terms of welding, the hood complies with standard UNI EN ISO 15012-2-2008, according to which the minimum collection speed detected on a surface, whose distance depends on the small hood shape ratio, is equal to 0.4 m/s, while the air flow rate is equal to 900 m<sup>3</sup>/h; therefore, the distance from the welding source must be 255 mm.

#### 4.4.2. LOSS/FLOW RATE CURVE

The selection of the suction device depends on the loss performance data (total pressure (TP) mm H<sub>2</sub>O) in relation to the arm flow rate (Q m<sup>3</sup>/h), as indicated in the diagram.

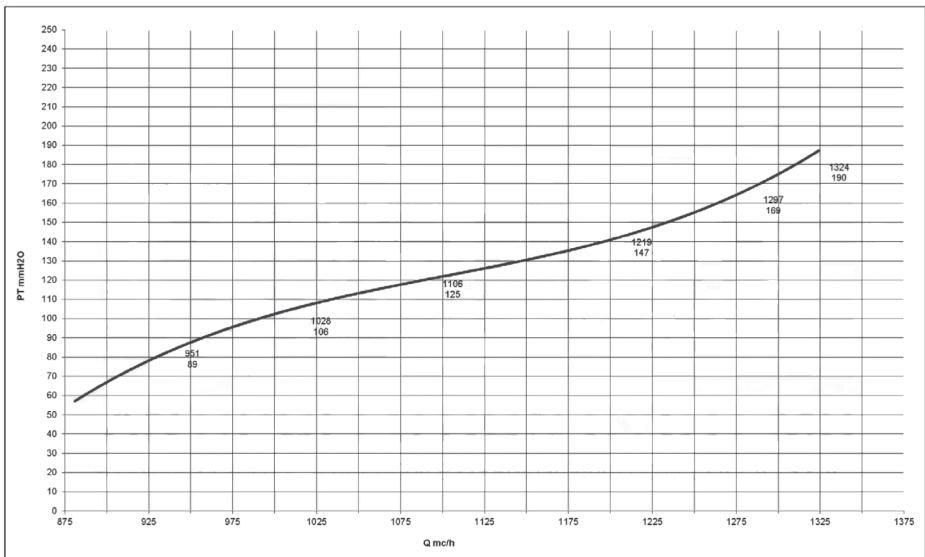

FLOW RATE [m <sup>3</sup> /h]	TOTAL PRESSURE (TP) mmH <sub>2</sub> O	TOTAL PRESSURE (TP) Pa
950	89	873
1025	108	1059
1100	125	1226
1220	147	1442
1300	170	1668
1325	190	1864

#### 4.5. DESCRIPTION OF PERIMETER AREAS



During installation, pay attention to the maximum overall dimensions of the arm.

MASTERFLEX  
CARRIAGE

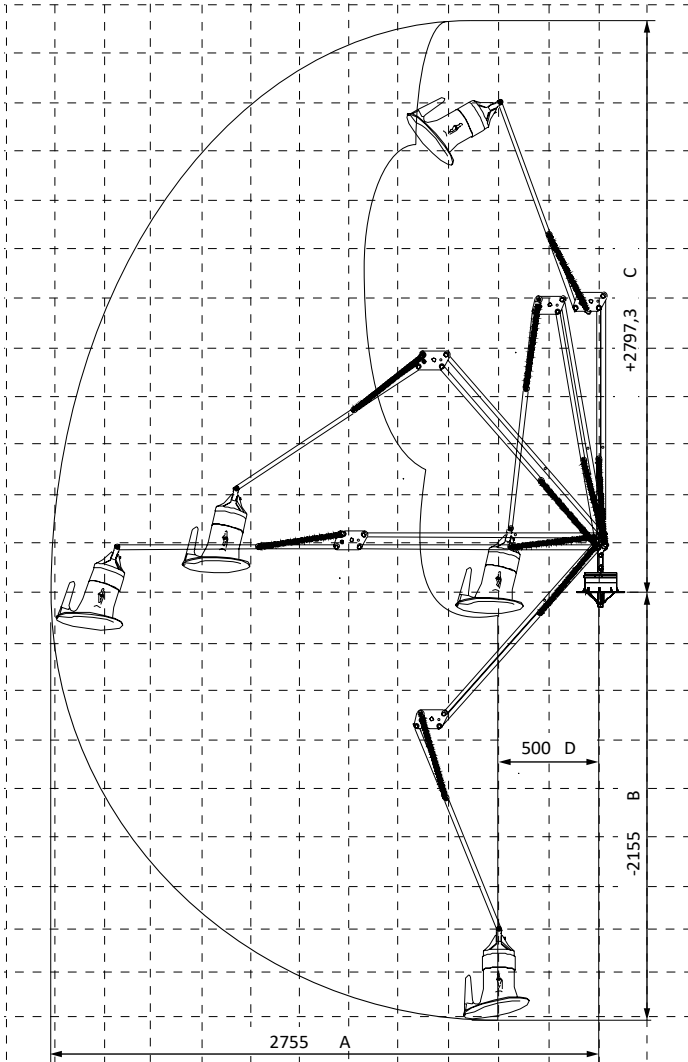

**MASTERFLEX  
WALL**

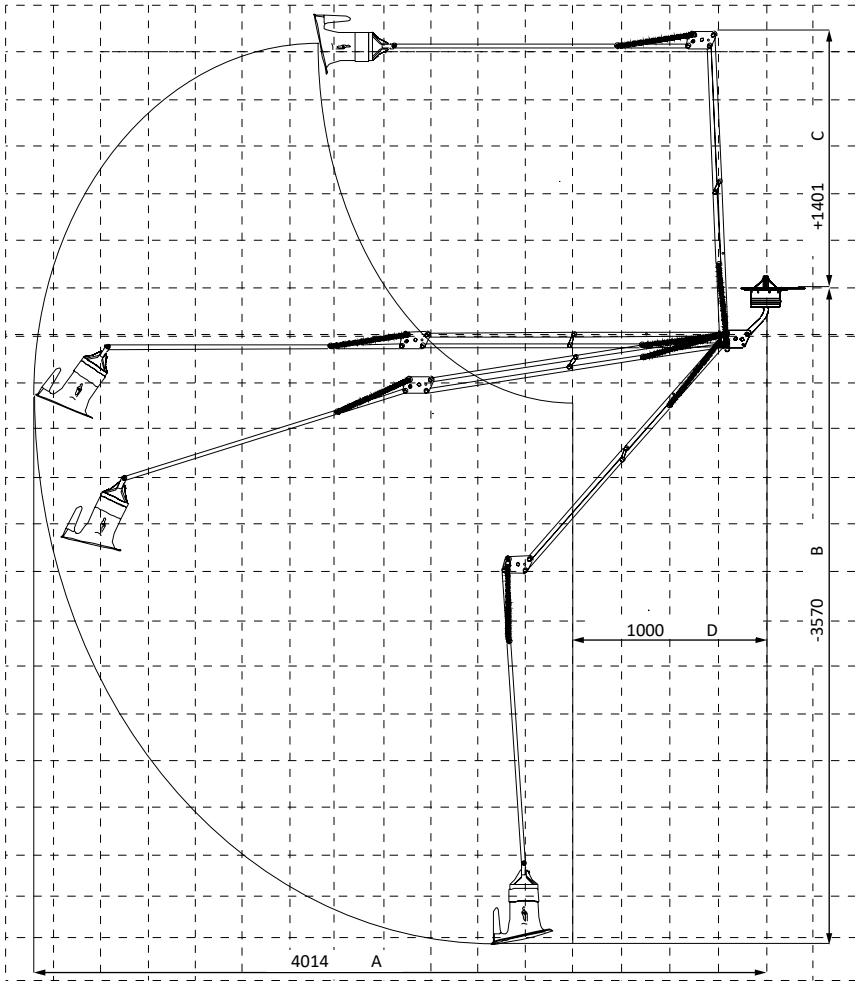

MACHINE MODEL	A	B	C	D
<b>MASTERFLEX160/2 - CARRIAGE</b>	1750 mm	1150 mm	1800 mm	500 mm
<b>MASTERFLEX160/3 - CARRIAGE</b>	2750 mm	2150 mm	2800 mm	500 mm
<b>MASTERFLEX160/3 - WALL</b>	3000 mm	2500 mm	900 mm	1000 mm
<b>MASTERFLEX160/4 - WALL</b>	4000 mm	3500 mm	1400 mm	1000 mm



## 5. INFORMATION ON USE

### 5.1. RECOMMENDATIONS FOR USAGE



The arm is designed to operate in closed facilities.



The arm is designed to operate in an ambient temperature between -20°C / +60°C.



The arm is designed to operate in negative pressure.



Comply with Technical Rule TRGS 560 (Air circulation during the use of carcinogenic and hazardous material) when suctioning carcinogenic welding fumes (e.g. chromates and Nickel oxides).



Position the arm extractor hood above the welded joint at a distance of approx. 270 mm. This position ensures optimum suction due to the rising of the hot gases. Otherwise, correct capture of the fumes containing dangerous substances cannot be guaranteed. This means the dangerous fumes may penetrate the operator's breathing apparatus and cause harm.

### 5.2. INTENDED USE/IMPROPER USE

#### 5.2.1. TYPE OF TREATED AIR

		TYPE OF TREATED AIR		
OPERATION	INTENDED	IMPROPER		WORK ENVIRONMENT
SUCTION of:	<ul style="list-style-type: none"> <li>Welding fumes from high alloy steel with nickel and chromium &gt;30%</li> </ul>	<ul style="list-style-type: none"> <li>Drawing in liquids</li> <li>Working in environments with an explosion hazard.</li> <li>Flammable or explosive vapour</li> <li>Potentially explosive metal powder</li> <li>Powder that may be explosive by nature or reaction.</li> </ul>		Produced during mechanical industry processing.

## 6. INFORMATION ON ADJUSTMENTS

### 6.1. RECOMMENDATIONS FOR ADJUSTMENTS

The arm is supplied with standard adjustment, which considers an initial power loss of the springs.

#### 6.1.1. GATE ADJUSTMENT

To regulate the air flow rate, close the gate to decrease it.

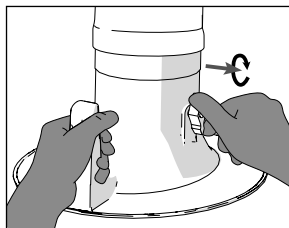





To adjust the gate, pull and turn as indicated in the image.

### 6.1.2. Adjusting the joint structure on the fifth wheel side

Use the bolt (X)(Y) indicated in the drawing to adjust the first section of the structure (fifth wheel side).

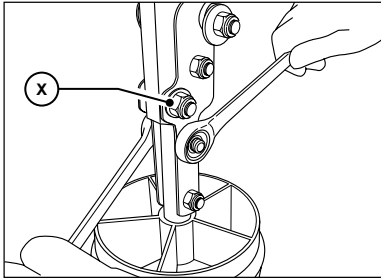

MASTERFLEX  
CARRIAGE

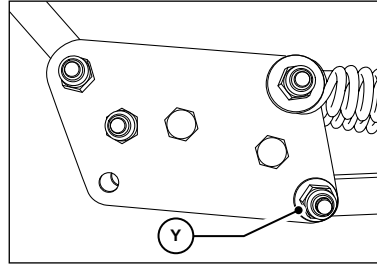

MASTERFLEX  
WALL

ADJUSTMENT TABLE Nm	CARRIAGE X	WALL Y
MasterFlex 2 mt	6 Nm	6 Nm
MasterFlex 3 mt	8 Nm	8 Nm
MasterFlex 4 mt	-	10 Nm

### 6.1.3. ADJUSTING THE CENTRAL JOINT STRUCTURE

Use bolts (H) and (W) indicated in the drawing to adjust the structure section (hood side).

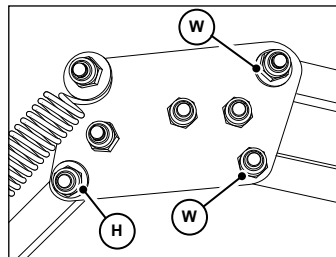

MASTERFLEX  
CARRIAGE

MASTERFLEX  
WALL

ADJUSTMENT TABLE Nm	WALL/CARRIAGE H	WALL/CARRIAGE W
MasterFlex 2 mt	6 Nm	6 Nm
MasterFlex 3 mt	8 Nm	8 Nm
MasterFlex 4 mt	10 Nm	8 Nm



**6.1.4. ADJUSTING THE HOOD JOINT**

Use the bolts (Z) indicated in the drawing to adjust the hood joint.

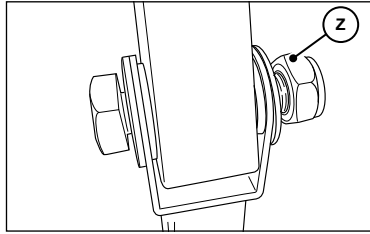

ADJUSTMENT TABLE Nm	CARRIAGE Z	WALL Z
MasterFlex 2 mt	7 Nm	7 Nm
MasterFlex 3 mt	7 Nm	7 Nm
MasterFlex 4 mt	-----	7 Nm

**7. MAINTENANCE INFORMATION**

**7.1. RECOMMENDATIONS FOR MAINTENANCE INTERVENTIONS**



Carefully read the instructions in this manual before any maintenance intervention.



The apparatus must be disassembled, cleaned, and maintained in good condition, as far as is reasonably possible, without causing risks to maintenance personnel or other persons.



Before disassembling the machine, ensure there is a suitable area that includes its own air filter, and with the necessary equipment needed to clean the maintenance area.



Perform maintenance activities using the personal protective equipment described in the manual.

**7.2. TABLE OF SCHEDULED MAINTENANCE INTERVALS**

Routine maintenance operations are to performed at the date shown in the table.

OPERATION	24 hours	250 hours	500 hours	1000 hours	1500 hours
Check all the screws and joints and tighten them if required.					•
Check the internal cleanliness of the arm.					•



OPERATION	24 hours	250 hours	500 hours	1000 hours	1500 hours
Clean the entire surface of the small hood in contact with pollutant agents.			•		
Check the state of the hose.			•		
Check the operation of the gate.			•		

### 7.3. CLEANING AND DISPOSAL



The information provided below serves the purpose of helping perform cleaning activities inside the machine to restore operation and efficiency.



Powder must be stored and disposed of in compliance with AdFG (law on waste disposal), and in an environmentally sound manner.



### 8. INFORMATION ON TROUBLESHOOTING



The following information has the purpose of helping to identify the anomalies and restore the machine operation and efficiency.

DEFECT	CAUSE	POSSIBLE SOLUTIONS
The adjustment gate fails to keep its position.	Possible failure of the teeth that allow the gate to keep its position.	Replace damaged parts.
The arm fails to keep its position in the fifth wheel side.	Loss of adjustment after the first use period or storage.	See adjustment information, section 6.1.2.
The arm fails to keep its position in the hood side.	Loss of adjustment after the first use period or storage.	See adjustment information, section 6.1.3.
The hood fails to keep its position	Loss of adjustment after the first use period or storage.	See adjustment information, section 6.1.4.
	Incorrect assembly of the friction washers.	Check the layout of the steel and friction washers (see image 6.1.4).

## 9. INFORMATION ON REPLACEMENTS

### 9.1. REQUESTING AFTER-SALES ASSISTANCE

If you need to order spare parts, proceed as follows:

1. Photocopy the form laid out below.
2. Complete the provided spaces.
3. Contact the area distributor or the assistance and spare parts department **MasterWeld**, sending a copy of the form completely filled out to the indicated e-mail address or fax number.

In answer to your request, you will be sent an offer including the price, delivery and sales conditions as soon as possible.



**ASSISTANCE AND SPARE PARTS DEPARTMENT**  
**MasterWeld, Olympic House, Southmead Park, Collett,**  
**Didcot, Oxfordshire, United Kingdom, OX11 7WB**  
**Tel: +44 (0) 1235 510 717 web: www.masterweld.co.uk**

### Spare Parts Offer Request Form

Goods sending address	Invoice sending address
-----------------------	-------------------------

Name of requesting party	Phone number	Delivered through:
	Fax number	Date

CODE MACHINE SERIAL NUMBER	YEAR OF MANUFACTURE	POS. NO.	DESCRIPTION	QUANTITY



## 9.2. RECOMMENDATIONS FOR REPLACEMENT INTERVENTIONS



The machine replacement or repair operations are reserved to qualified, trained and authorised personnel, employed by the Manufacturer or by the Authorised Assistance Centre.

## 9.3. LIST OF REPLACEABLE COMPONENTS

POS.	ELEMENT
1	Fifth wheel
2	Pair of joint springs (fifth wheel side)
3	Fifth wheel gasket
4	Pair of (central) joint springs
5	Elastic hoses clamp
6	Steel hoses clamp
7	Hose
8	Complete small hood
9	Gate kit
10	Cup spring
11	Friction washer

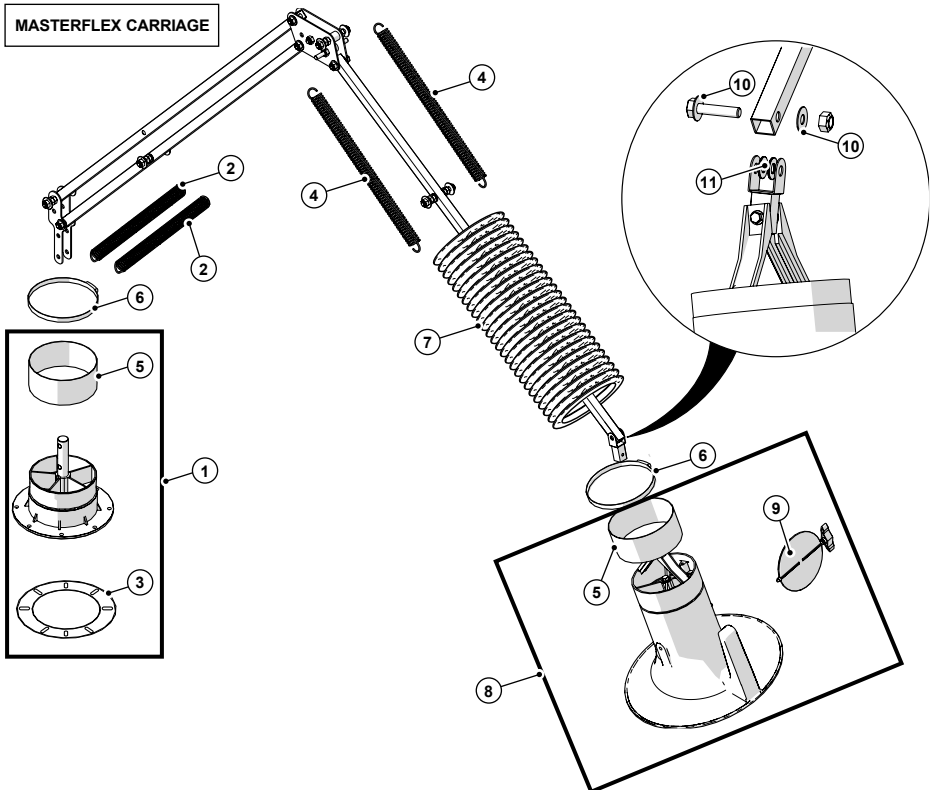

**MASTERWELD WALL**

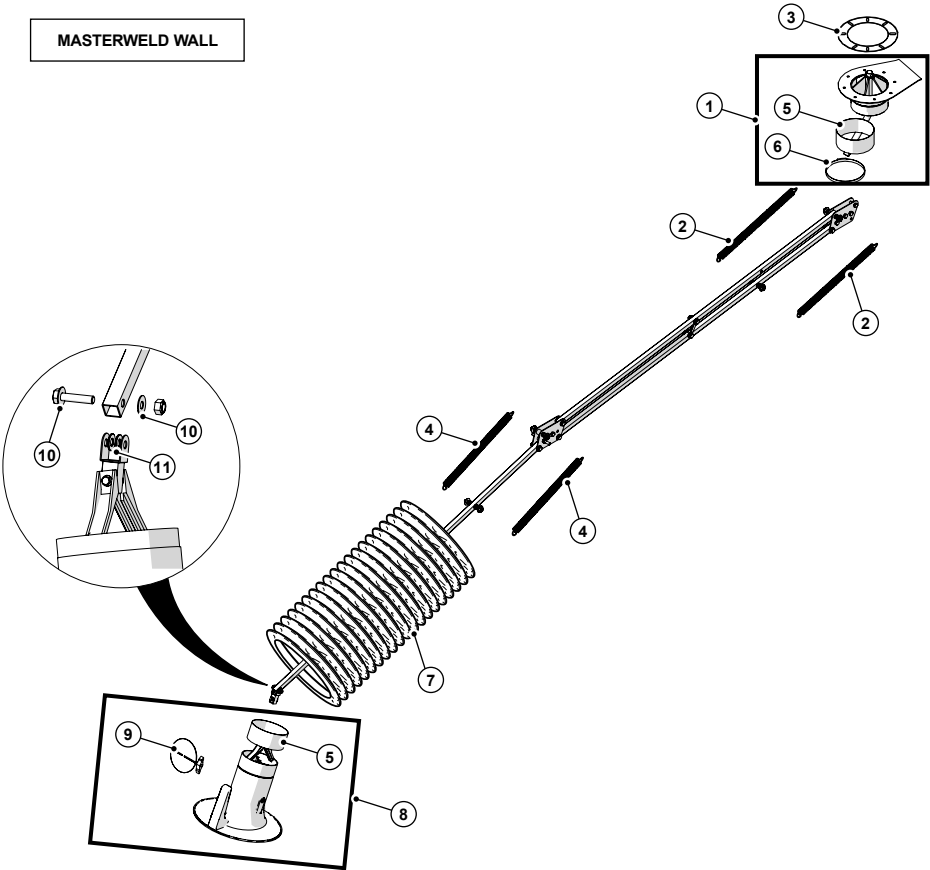

**9.3.1. OPTIONAL**

POS.	ELEMENT
1	Sparks stop net kit

**9.4. SCRAPPING AND DECOMMISSIONING**

The machine does not have any particular problems as regards to decommissioning. Proper care shall be taken to prevent unauthorised personnel from starting the machine. Comply with the laws in force in the country of use, for any legal and tax aspects (any reports, complaints, etc...).



# The Welders' Ultimate Choice



---

## MasterWeld

Olympic House, Southmead Park, Collett, Didcot, Oxfordshire, United Kingdom, OX11 7WB

Tel: +44 (0) 1235 510 717 Web: [www.masterweld.co.uk](http://www.masterweld.co.uk)

