



Masterweld 301 PLUS



CONTENTS

1	INTRODUCTION	4
2	INSTALLATION	5
2.1	CONNECTIONS TO THE ELECTRICAL MAINS NETWORK	5
2.2	FRONT PANEL	5
2.3	REAR PANEL	5
2.4	PREPARING FOR MMA WELDING	6
2.5	PREPARING FOR TIG WELDING	7
2.6	PREPARING FOR MIG/MAG WELDING	8
2.6.1	WIRE SPOOL POSITIONING	8
2.6.2	POSITIONING THE WIRE IN THE WIRE FEEDER	8
2.6.3	CONNECTIONS TO SOCKETS	9
3	COMMISSIONING	11
3.1	USER INTERFACE	11
3.2	UNIT POWER-UP	13
3.3	RESET (LOAD FACTORY SETTINGS)	13
3.4	GAS FLOW ADJUSTMENT	14
3.5	ALARMS MANAGEMENT	14
4	WELDING SETTINGS	15
4.1	TORCH TRIGGER MODES	15
4.2	SELECTION OF THE WELDING MODE AND TORCH TRIGGER PROCEDURE	16
4.3	PARAMETERS ACTIVATION	16
4.4	WELDING PARAMETERS	17
4.5	ELECTRODE WELDING (MMA)	18
4.5.1	PARAMETERS SETTING: WELDING CURRENT	18
4.5.2	PARAMETERS SETTING: HOT-START	18
4.5.3	PARAMETERS SETTING: ARC FORCE	18
4.6	DC TIG WELDING	18
4.6.1	PARAMETERS SETTING: WELDING CURRENT	18
4.6.2	PARAMETERS SETTING: POST GAS TIME	18
4.7	MIG/MAG WELDING	19
4.7.1	PARAMETERS SETTING: MIG/MAG WELDING VOLTAGE	19
4.7.2	PARAMETERS SETTING: WIRE FEED RATE	19
4.7.3	PARAMETERS SETTING: INDUCTANCE SETTING	19
4.7.4	PARAMETERS SETTING: POST GAS TIME	19
4.7.5	PARAMETERS SETTING: SPEED LIMIT	19
4.7.6	ADJUSTMENT WELDING PARAMETERS PANEL	20
5	TECHNICAL DATA	21
6	SPARE PARTS	23
6.1	WIRE FEED MOTOR	25
6.2	WIRE FEEDER ROLLS	26
7	ELECTRICAL DIAGRAM	27
7.1	MICROMAG 301 PLUS	27

1 INTRODUCTION



IMPORTANT!

This handbook must be consigned to the user prior to installation and commissioning of the unit.
Read the "General prescriptions for use" handbook supplied separately from this handbook before installing and commissioning the unit.
The meaning of the symbols in this manual and the associated precautionary information are given in the "General prescriptions for use".
If the "General prescriptions for use" are not present, it is mandatory to request a replacement copy from the manufacturer or from your dealer.
Retain these documents for future consultation.

KEY



DANGER!

This pictogram warns of danger of death or serious injury.



WARNING!

This pictogram warns of a risk of injury or damage to property.





CAUTION!

This pictogram warns of a potentially hazardous situation.



INFORMATION

This pictogram gives important information concerning the execution of the relevant operations.

-  This symbol identifies an action that occurs automatically as a result of a previous action.
-  This symbol identifies additional information or a reference to a different section of the manual containing the associated information.
-  This symbol identifies a reference to a chapter of the manual.

NOTES

The figures in this manual are purely guideline and the images may contain differences with respect to the actual equipment to which they refer.

INTRODUCTION

The Masterweld 301 PLUS is a compact and heavy duty generator for MIG/MAG welding.

The reduced weight and compact size allow it to be carried wherever it is needed. It is designed to give you the maximum power, reliability and efficiency.

Set up the power source for MMA, MIG/MAG or TIG operation on the selector switch located on the rear of the panel in the motor compartment.

Wire reels of up to 200 mm in diameter can be mounted.

Sound alarm. A sound alarm has been provided to protect the power generator: it blocks the primary inverter in the event that the average welding current should exceed 310 A for more than 0.6 seconds.

Fan. The fan is turned on only during welding, at the end of the welding process it remains on for a fixed period of time according to welding conditions. The fan is nonetheless controlled by specific thermal sensors that guarantee a correct cooling of the machine.

Accessories that can be connected to the unit:

- Flow meter for adjustment of the gas outlet flow from the welding torch in litres/minute.

Consult your dealer for an updated list of accessories and the latest available new products.

2 INSTALLATION

DANGER!
Lifting and positioning

Read the warnings highlighted by the following symbols in the "General prescriptions for use".



2.1 CONNECTIONS TO THE ELECTRICAL MAINS NETWORK

The characteristics of the mains power supply to which the equipment shall be connected are given in the section entitled "Technical data" on page 21.

The machine can be connected to motorgenerators provided their voltage is stabilised.

Connect/disconnect the various devices with the machine switched off.

2.2 FRONT PANEL

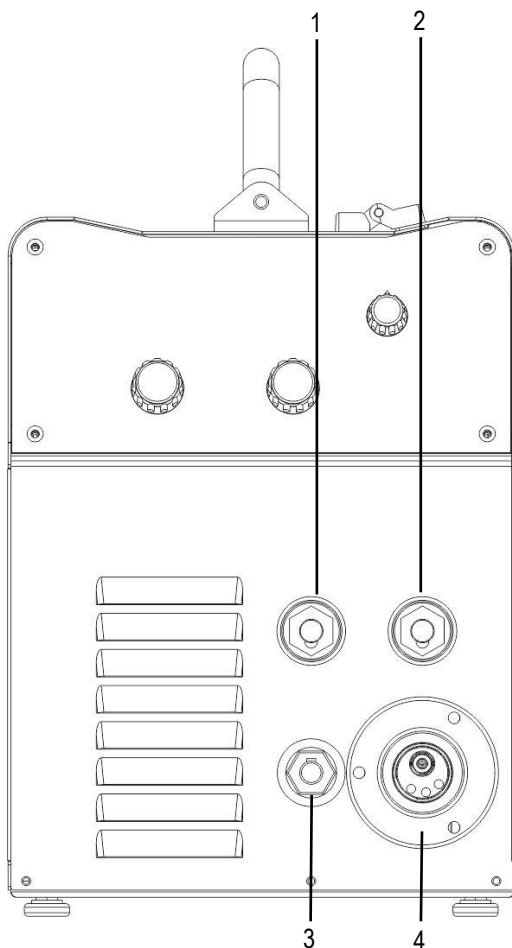

1. Positive pole welding socket.
2. Negative pole welding socket.
3. Polarity selector cable.
4. EURO TORCH welding socket.

2.3 REAR PANEL

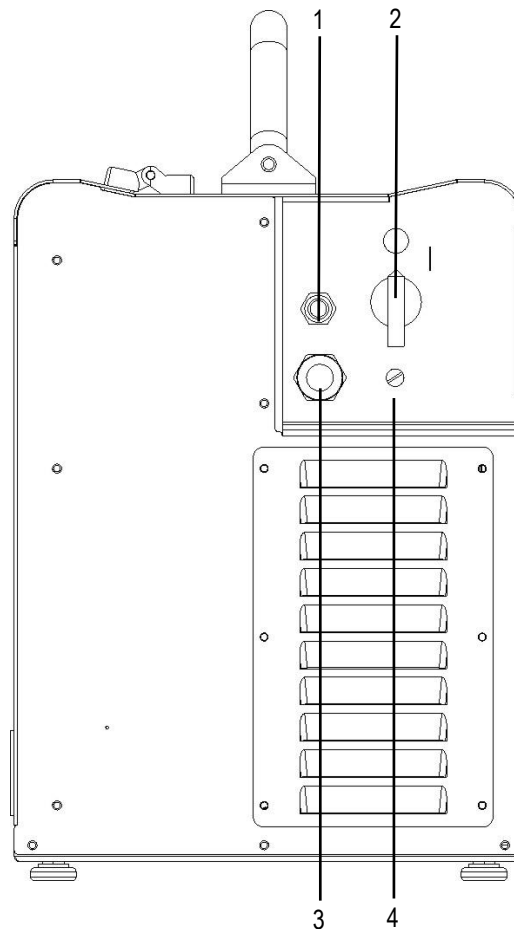

1. Connector for gas feed hose:
cylinder → power source
2. Welding power source ON/OFF switch.
3. Power cable.
Total length (including internal part): 3,5 m
- ④ Number and cross section of wires: 4 x 1,5 mm²
Power plug type: not supplied
4. Flow meter.
(Purchasing and installing the relative kit).

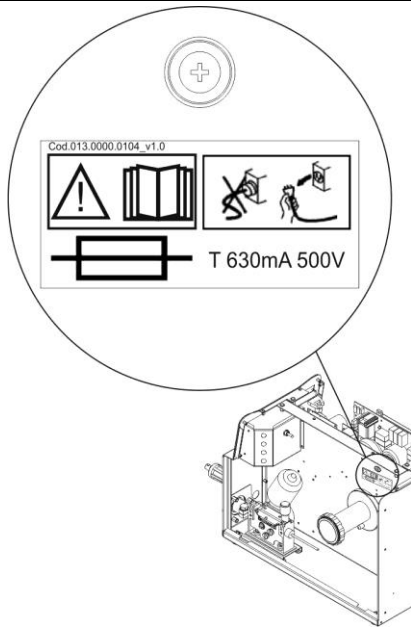

Wire feed motor power transformer fuse.

Type: Delayed acting (T)

Amperage: 630 mA

Voltage: 500 V

2.4 PREPARING FOR MMA WELDING

1. Set the welding power source ON/OFF switch to "O" (unit de-energized).
2. Plug the power cable plug into a mains socket outlet.
3. Choose the electrode based on the type of material and thickness of the workpiece to be welded.
4. Insert the electrode in the electrode holder.
5. Connect the electrode holder cable to the welding socket based on the polarity requested by the type of electrode used.
6. Connect the plug of the ground clamp to the welding socket on the basis of the polarity required.
7. Connect the earth clamp to the workpiece being processed.



DANGER! Electric shock hazard!

Read the warnings highlighted by the following symbols in the "General prescriptions for use".



8. Set the welding power source ON/OFF switch to "I" (unit powered).
9. Select the following welding mode on the selector located in the spool compartment: MMA

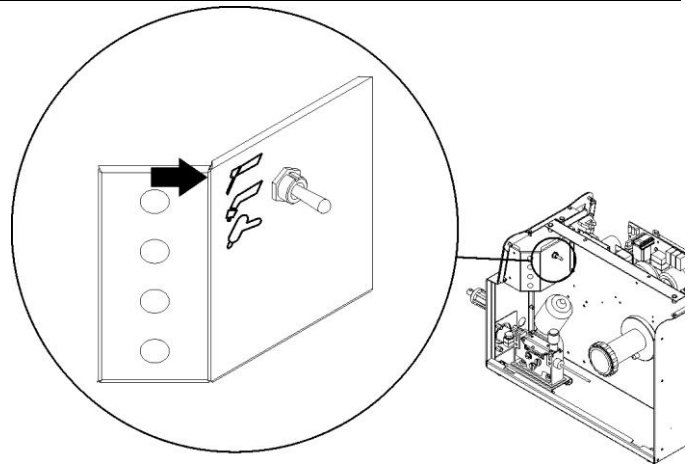

10. Set the required welding parameter values on the user interface. The system is ready to start welding.

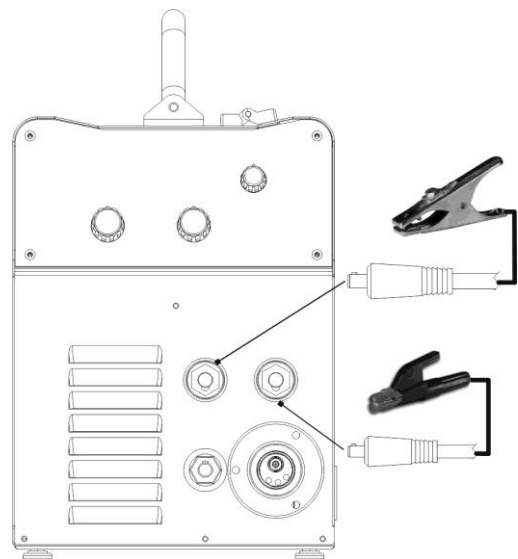
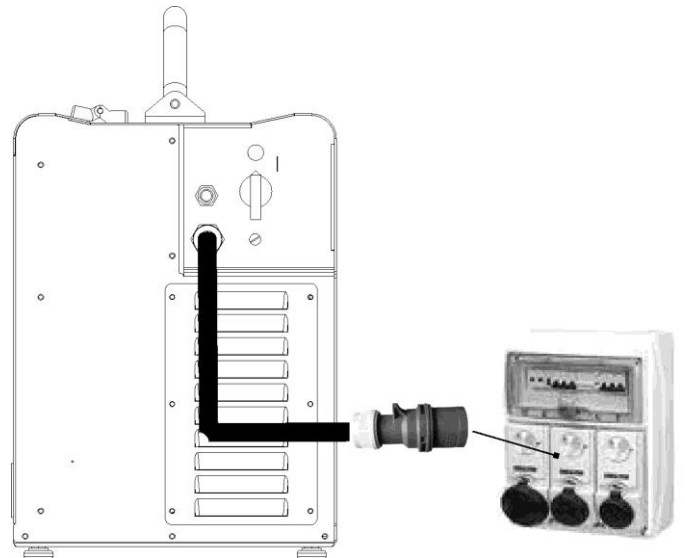

Preparing for MMA (polarity to basic electrode)

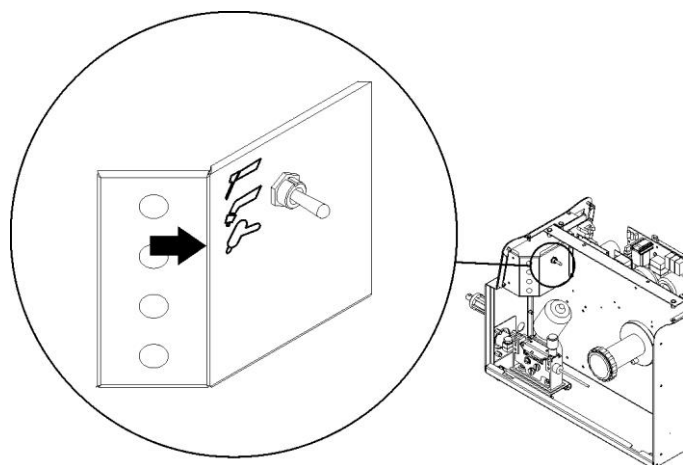

2.5 PREPARING FOR TIG WELDING

1. Set the welding power source ON/OFF switch to "O" (unit de-energized).
2. Plug the power cable plug into a mains socket outlet.
3. Connect the gas hose from the welding gas cylinder to the rear gas socket.
4. Open the cylinder gas valve.
5. Connect the TIG torch plug to the EURO TORCH welding socket.
6. Choose the electrode based on the type of material and thickness of the workpiece to be welded.
7. Insert the electrode in the TIG torch.
8. Connect the plug of the polarity selector cable to the welding socket on the basis of the polarity required.
9. Connect the plug of the ground clamp to the welding socket on the basis of the polarity required.
10. Connect the earth clamp to the workpiece being processed.
11. Set the welding power source ON/OFF switch to "I" (unit powered).
12. Select the following welding mode on the selector located in the spool compartment: DC TIG



13. Open the gas solenoid valve by pressing and releasing the button .
14. Use the flow control valve to adjust the flow of gas as required while the gas is flowing out.
15. Close the gas solenoid valve by pressing and releasing the button .
16. Set the required welding parameter values on the user interface.
The system is ready to start welding.

Preparing for TIG (polarity for tungsten electrode)

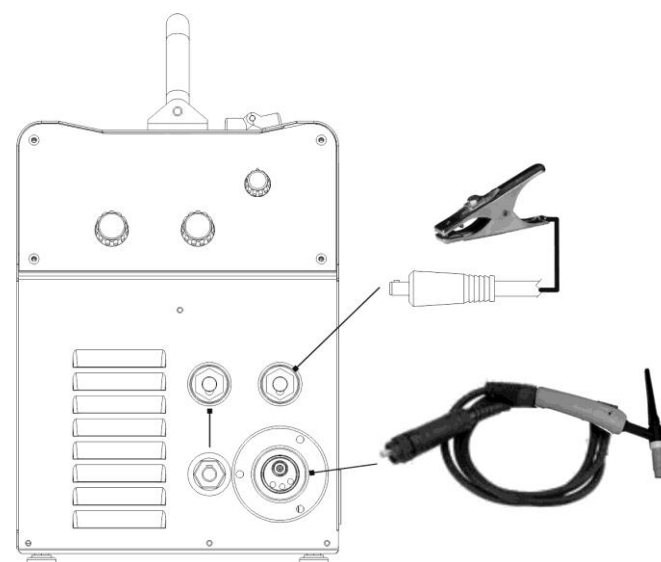
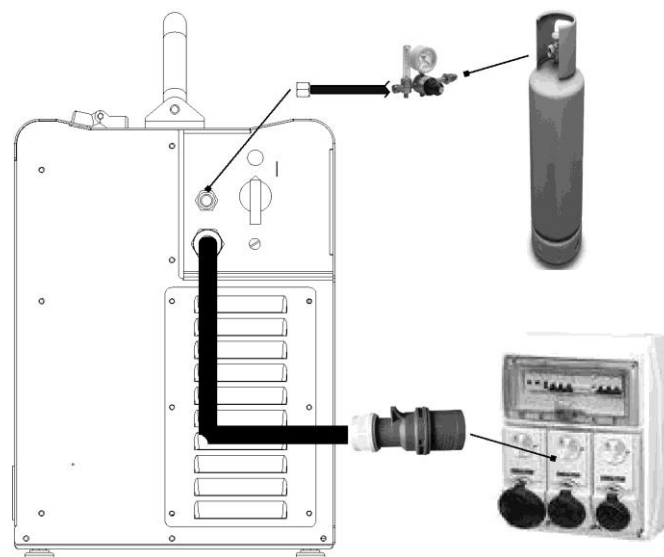

2.6 PREPARING FOR MIG/MAG WELDING

2.6.1 WIRE SPOOL POSITIONING

1. Open the unit side door to gain access to the spool compartment.
2. Unscrew the cap of the spool holder.



3. If necessary, fit an adapter for the wire spool.

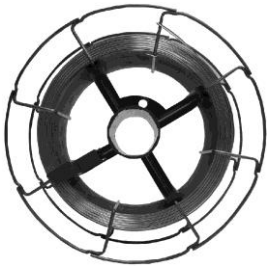

4. Choose the wire on the basis of the workpiece thickness and material type.
5. Fit the spool in the spool holder, ensuring it is located correctly.



6. Adjust the spool holder braking system by tightening/loosening the screw in such a way that the wire feed force is not excessive and when the spool stops rotating no excess wire is released.

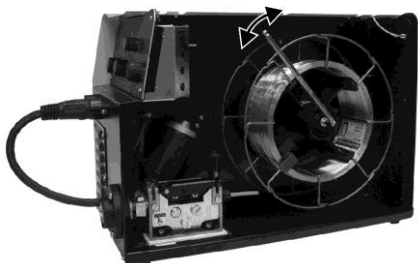

7. Refit the plug.



2.6.2 POSITIONING THE WIRE IN THE WIRE FEEDER

1. Lower the wire feeder pressure devices.

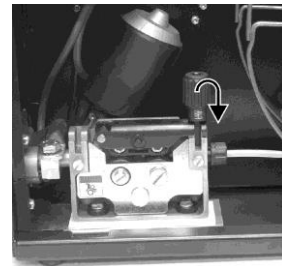

2. Raise the wire feeder pressure arms.
3. Remove the protective cover.

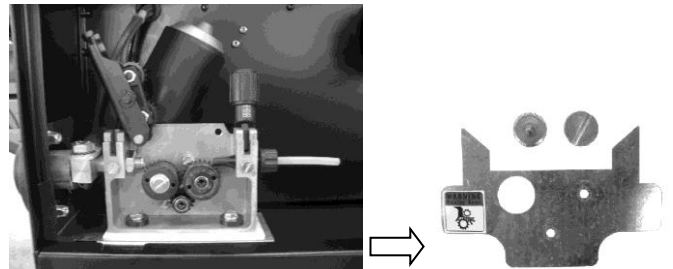

4. Check that the feed rolls are suitable for the wire gauge.

(See § 6.2 page 26.)

The diameter of the roll groove must be compatible with the diameter of the welding wire.

The roll must be of suitable shape in relation to the composition of the wire material.

- The groove must feature a "U" profile for soft materials (Aluminium and its alloys, CuSi3).

The groove must be "V" shaped for harder materials (SG2-SG3, stainless steels).

Rolls with a knurled groove profile are available for flux-cored wire.

5. Feed the wire between the wire feeder rolls and insert it into the MIG/MAG TORCH connector plug.
6. Make sure the wire is located correctly in the roll grooves.

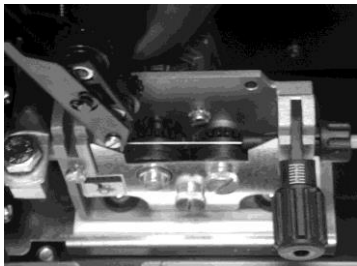

7. Close the wire feeder pressure arms.
8. Adjust the pressure system so that the arms press the wire with a force that does not deform it while also ensuring constant feed rate without slipping.

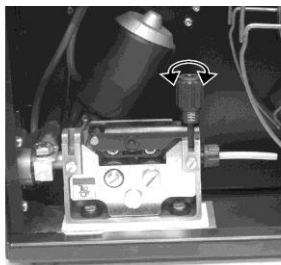



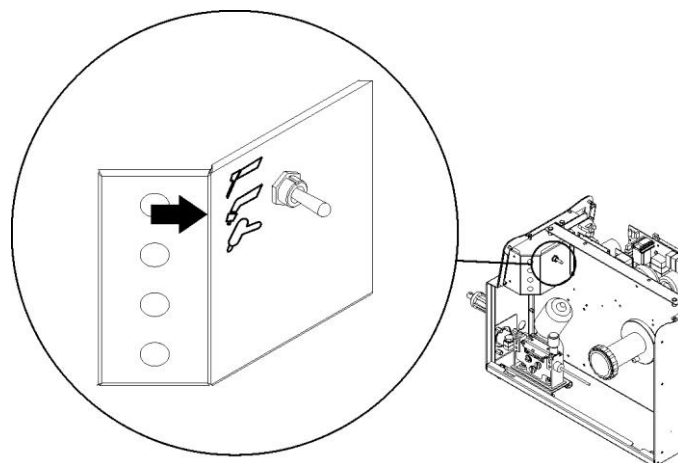

9. Refit the protective cover.
10. Close the spool compartment door in the side of the unit.

2.6.3 CONNECTIONS TO SOCKETS

1. Set the welding power source ON/OFF switch to "O" (unit de-energized).
2. Plug the power cable plug into a mains socket outlet.
3. Connect the gas hose from the welding gas cylinder to the relative socket.
4. Open the cylinder gas valve.
5. Connect the MIG/MAG torch plug to the EURO TORCH welding socket.
6. Connect the plug of the ground clamp to the welding socket on the basis of the polarity required.
7. Connect the plug of the polarity selector cable to the welding socket on the basis of the polarity required.
8. Connect the earth clamp to the workpiece being processed.
9. Set the welding power source ON/OFF switch to "I" (unit powered).
10. Select the following welding mode on the selector located in the spool compartment: MIG/MAG



11. Feed the wire through the torch until it protrudes from the tip, pressing button  on the unit's user interface.
 The insertion speed is 2 m/min for 3 seconds, subsequently increasing to 15 m/min. When the button is released wire feed is interrupted.
 This function produces a slower feed rate and hence greater precision when inserting the wire when it enters the torch nozzle.
12. Select the torch trigger procedure on the user interface.
13. Open the gas solenoid valve by pressing and releasing the button .
14. Use the flow control valve to adjust the flow of gas as required while the gas is flowing out.
15. Close the gas solenoid valve by pressing and releasing the button .
16. Set the required welding parameter values on the user interface.
The system is ready to start welding.

Preparing for MIG/MAG

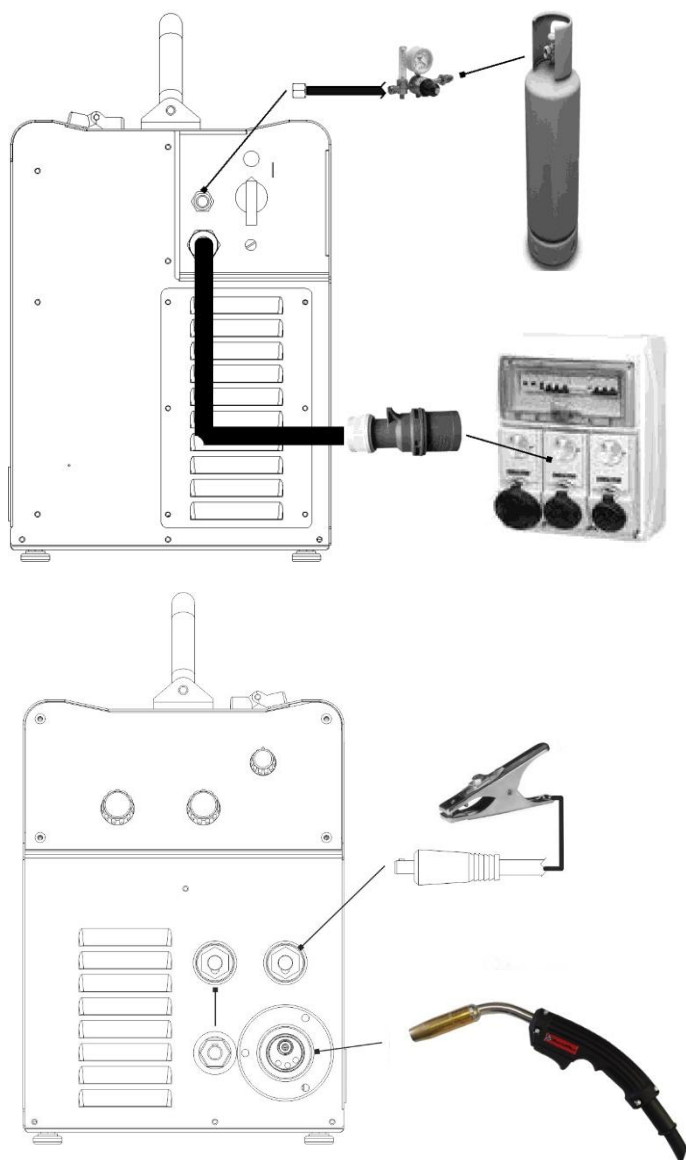

The above diagram shows the MIG welding torch to be the Masterweld MW300. Although lightweight this torch has a 300 amp bicox cable, designed to withstand the amperage capacity and the OCV (Open Circuit Voltage) of the machine. We recommend the use of this torch best arc characteristics and consumable life.

3 COMMISSIONING

3.1 USER INTERFACE

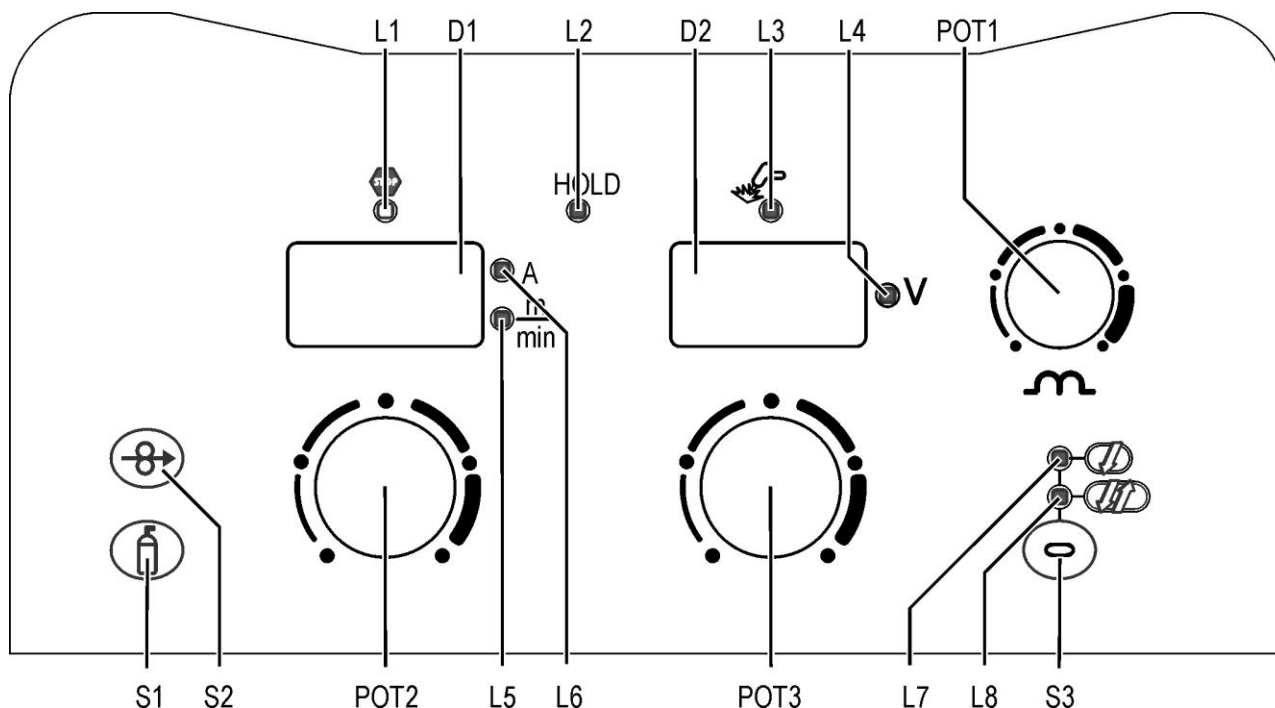

CODE	SYMBOL	DESCRIPTION
L1		This LED illuminates to show an anomaly in the operating conditions. ① See § 3.5 ALARMS MANAGEMENT page 14.
L2	HOLD	Illumination of this LED indicates the display of the average voltage and current value measured during the final moments of welding. The value appears on the following displays: D1-D2
L3		This LED illuminates to confirm the presence of power on the output sockets.
L4	V	Illuminates to show a value in the following unit of measurement: VOLTS
L5	m/min	Illuminates to show a value in the following unit of measurement: METRES PER MINUTE
L6	A	Illuminates to show a value in the following unit of measurement: AMPERES
L10		Illumination shows that the following function has been activated: 2 stroke procedure.
L11		Illumination shows that the following function has been activated: 4 stroke procedure.
D1		<p>Parameters/functions setting MIG/MAG mode: the display shows the programmed wire feed rate. MMA mode: the display shows the ampere value set for welding. TIG Mode: the display shows the ampere value set for welding.</p> <p>Welding The display shows the effective amperes value during welding.</p> <p>Menu function The display shows the acronym of the parameter or function to be adjusted.</p>
D2		<p>Parameters/functions setting Manual MIG/MAG mode: the display shows the programmed voltage. MMA mode: The display shows "MMA". TIG Mode: The display shows "tIG".</p> <p>Welding The display shows the effective voltage value during welding.</p> <p>Menu function The display shows the value of the parameter or function to be adjusted.</p>

CODE	SYMBOL	DESCRIPTION
S1		This button opens the gas solenoid valve to fill the circuit and calibrate the pressure with the regulator on the gas cylinder. POST-GAS adjustment Hold down the button for 3 seconds to open the menu. (See § 4.6.2 page 18.)
S2		MIG/MAG mode: this button activates wire feed to insert it through the MIG/MAG torch. SPEED LIMIT adjustment Hold down the button for 3 seconds to open the menu. (See § 4.7.5 page 19.)
S3		MIG/MAG mode: this button selects the torch trigger procedure. HOT-START adjustment Hold down the button for 3 seconds to open the menu. (See § 4.5.2 page 18.)
POT1		MIG/MAG mode: the potentiometer sets the inductance value. MMA mode: the potentiometer sets the value of the following parameter: ARC FORCE
POT2		Parameters/functions setting MIG/MAG mode: the potentiometer sets the value of the following parameter: WIRE FEED RATE Menu function The potentiometer selects the function or parameter to be adjusted.
POT3		Parameters/functions setting MIG/MAG mode: the potentiometer sets the welding mode. Menu function the potentiometer sets the value of the selected function or parameter.
SEL1		The selector sets the welding mode.

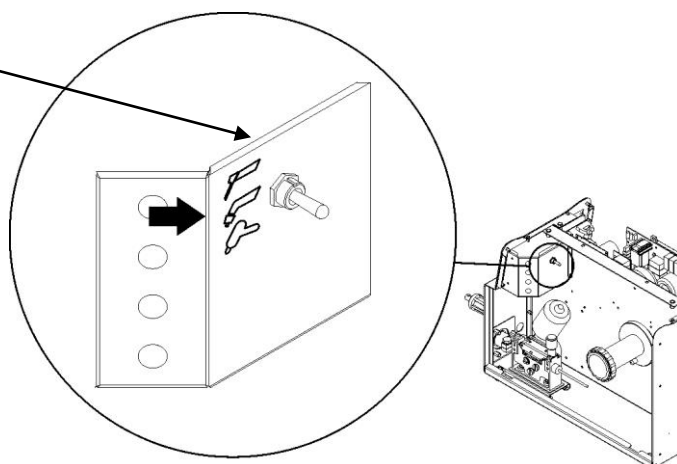

3.2 UNIT POWER-UP

Set the welding power source ON/OFF switch to "I" to switch on the unit.

➡ **AL.HEA.** The message appears for a few seconds on the following displays: D1-D2

First power-up or power-ups following a RESET procedure

➡ The welding power source sets up for welding with the factory presets.

Subsequent power-ups

➡ The welding power source sets up for welding in the latest stable welding configuration that was active at the time of power-off.

3.3 RESET (LOAD FACTORY SETTINGS)



The reset procedure involves complete restoration of the default values, parameters and memory settings set in the factory.

All memory locations will be reset and hence all your personal welding settings will be lost!

The reset procedure is useful in the following cases:

- Too many changes made to the welding parameters so user finds it difficult to restore defaults.
- Unidentified software problems that prevent the welding power source from functioning correctly.

Set the welding power source ON/OFF switch to "O" to switch the unit off.

S1  S3  Hold down both buttons simultaneously.

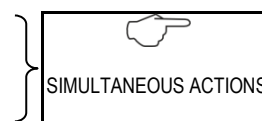

Set the welding power source ON/OFF switch to "I" to switch on the unit.





➡ **FAC** The message appears on the following displays: D2
Release buttons.

3.4 GAS FLOW ADJUSTMENT

When the unit is powered on the solenoid valve opens for 1 second.
This serves to fill the gas circuit.

- S1  Open the gas solenoid valve by pressing and releasing the button.
Adjust the pressure of gas flowing from the torch by means of the flow meter connected to the gas cylinder.
- S1  Close the gas solenoid valve by pressing and releasing the button.
The solenoid valve closes automatically after 15 seconds.

3.5 ALARMS MANAGEMENT

-  This LED illuminates if an incorrect operating condition occurs.
-  An alarm message appears on the following display: D1-D2

Tab. 1 - Alarm messages

MESSAGE	MEANING	EVENT	CHECKS
AL. HEA.	Overheating alarm Indicates tripping of the welding power source thermal protection.	All functions disabled. Exceptions: - cooling fan.	<ul style="list-style-type: none"> - Make sure that the power required by the welding process is lower than the maximum rated power output. - Check that the operating conditions are in compliance with the welding power source data plate specifications. - Check for the presence of adequate air circulation around the welding power source.
		Leave the unit running so that the overheated components cool as rapidly as possible. When the unit has cooled, the welding power source will reset automatically.	
AL. Cur.	Overcurrent alarm Indicates tripping of the welding power source current surge protection.	All functions disabled. Exceptions: - cooling fan.	<ul style="list-style-type: none"> - Check that the programmed arc voltage value is not too high in relation to the thickness of the work to be welded.
		An audible signal will sound (buzzer).	
		Muting the audible signal: - in torch trigger procedure 2T, release the torch trigger. - in torch trigger procedure 4T the alarm mutes automatically after 5 seconds.	
		Exit the alarm state by performing one of the following actions: - press any button. - switch the power source off.	

4 WELDING SETTINGS

4.1 TORCH TRIGGER MODES

2 STROKE LIFT-ARC TIG WELDING (2T)

1. Touch the workpiece with the torch electrode.
2. Press (1T) and keep the torch trigger pressed.
3. Slowly lift the torch to strike the arc.
 - ➡ The welding current reaches the preset value, by way of a up slope time, if programmed.
4. Release (2T) the trigger to start the weld completion procedure.
 - ➡ The current reaches the end current value in the time set in the down slope time parameter.
 - ➡ The arc is extinguished.
 - ➡ Gas delivery continues for the time set in the post gas parameter.

4 STROKE LIFT-ARC TIG WELDING (4T)

1. Touch the workpiece with the torch electrode.
2. Press (1T) and release (2T) the torch trigger.
3. Slowly lift the torch to strike the arc.
 - ➡ The welding current reaches the preset value, by way of a up slope time, if programmed.
4. Press (3T) the trigger and keep it pressed to start the weld completion procedure.
 - ➡ The current reaches the end current value in the time set in the down slope time parameter.
 - ➡ The arc continues and the current output will be the value set in the end current parameter.
 - ⓘ In these conditions the weld pool can be closed (crater filler current).
5. Release (4T) the trigger to extinguish the arc.
 - ➡ Gas delivery continues for the time set in the post gas parameter.

2 STROKE MIG/MAG WELDING (2T)

1. Bring the torch up to the workpiece.
2. Press (1T) and keep the torch trigger pressed.
 - ➡ The wire advances at the approach speed until making contact with the work. The arc strikes and the wire feeder accelerates to the set feed rate value.
3. Release (2T) the trigger to start the weld completion procedure.
 - ➡ Gas flow continues for the time set in the post gas parameter (adjustable time).

4 STROKE MIG/MAG WELDING (4T)

1. Bring the torch up to the workpiece.
2. Press (1T) and release (2T) the torch trigger.
 - ➡ The wire advances at the approach speed until making contact with the work. The arc strikes and the wire feeder accelerates to the set feed rate value.
3. Press (3T) the trigger to start the weld completion procedure.
 - ➡ Gas flow continues until the torch trigger is released.
4. Release (4T) the torch trigger to start the post gas procedure (adjustable time).

4.2 SELECTION OF THE WELDING MODE AND TORCH TRIGGER PROCEDURE

SEL1 Use this selector to select one of the following welding modes.



S3 Use this button to select one of the following torch trigger procedures.



MODE	PROCEDURE	
	2 STROKE	4 STROKE
MMA		
TIG DC CONTINUOUS	✓	✓
MIG/MAG	✓	✓

4.3 PARAMETERS ACTIVATION

The welding parameters are available in accordance with the selected welding mode and procedure. The table shows the settings required to enable each parameter.

MODE →			
PROCEDURE →			
PARAMETER ↓			
WELDING CURRENT	✓	✓	✓
HOT-START	✓		
ARC FORCE	✓		
POST GAS TIME		✓	✓
MIG/MAG WELDING VOLTAGE			✓
WIRE FEED RATE			✓
SPEED LIMIT			
INDUCTANCE			✓
SOFT-ARC			✓
BURN-BACK			✓
SOFT-START			✓
MOTOR SLOPE			✓

4.4 WELDING PARAMETERS

WELDING CURRENT

Output current value during welding.

HOT-START

This parameter aids electrode melting at the time of arc striking.

Consequences of a higher value:

- Easier arc strike.
- Increased spatter at welding start.
- Increase of strike area.

Consequences of a lower value:

- More difficult arc strike.
- Less spatter at welding start.
- Smaller strike area.

ARC FORCE

This parameter helps to avoid electrode sticking during welding.

During electrode fusion low conductivity parts of the coating become detached and tend to become interposed between the electrode tip as it is fusing and the workpiece. This condition results in an interruption of the arc. In addition, it may occur that the electrode comes into contact with the workpiece creating a short circuit and consequent quenching of the arc. To avoid arc quenching the power source therefore delivers instantaneous peak currents in correspondence with preset arc voltage thresholds.

Consequences of a higher value:

- Fluidity during welding.
- Welding arc stability.
- Greater electrode fusion in workpiece.
- More welding spatter.

Consequences of a lower value:

- The arc is extinguished more easily.
- Less welding spatter.

POST GAS TIME

Time of post gas delivery when the welding arc is extinguished.

This is useful when welding at high current values or with materials that oxidise readily to cool the weld pool in an uncontaminated atmosphere.

In the absence of specific requirements the value should generally be kept low.

Consequences of a higher value:

- More effective pickling (improved appearance of workpiece at the end of the welding pass).
- Higher gas consumption.

Consequences of a lower value:

- Lower gas consumption.
- Oxidation of electrode tip (more difficult arc strike).

MIG/MAG WELDING VOLTAGE

The parameter sets the welding voltage in MIG/MAG mode.

WIRE FEED RATE

The parameter sets the output wire feed rate.

The maximum speed setting can be limited by adjusting the "speed limit" parameter.

SPEED LIMIT

The parameter limits maximum motor speed, which is adjustable by means of the potentiometer.

INDUCTANCE

Consequences of a higher value:

- "Softer welding".
- Less spatter.
- Less positive starting.

Consequences of a lower value:

- "Harder welding".
- More spatter.
- More reliable starting.

SOFT-ARC

A parameter that optimises the welding of aluminium and stainless steel with thin thicknesses.

BURN-BACK

The burn back value is associated with the quantity of wire that is burnt at the end of the welding procedure.

Consequences of a higher value:

- Wire significantly retracted into the torch nozzle.

Consequences of a lower value:

- Stick-out at welding start is longer.

SOFT-START

The soft start is the wire approach speed to the workpiece.

The value is expressed as a percentage of the set feed rate.

Consequences of a lower value:

- The start of welding is "softer".

Consequences of a higher value:

- The welding start may prove difficult.

MOTOR SLOPE

Time required to switch from SOFT START speed to welding speed.

4.5 ELECTRODE WELDING (MMA)

SEL1 Select the following welding mode on the selector located in the spool compartment: MMA

 MMA The message appears on the following displays: D2

4.5.1 PARAMETERS SETTING: WELDING CURRENT

E1  Using the potentiometer, edit the value of the parameter.

 The value appears on the following display: D1

PARAMETER	MIN	DEFAULT	MAX
WELDING CURRENT	10 A	80 A	250 A

4.5.2 PARAMETERS SETTING: HOT-START

S3  Hold down the button for 3 seconds to open the menu.

 The acronym relative to the setting to be edited appears on the following displays: D1

 The value relative to the selected setting appears on the following displays: D2

POT3  Using the potentiometer, edit the value of the selected setting.

 Press any button to save the setting and quit the menu.

ACRONYM	PARAMETER	MIN	DEFAULT	MAX
H.S.	HOT-START	0 %	50 %	100 %

4.5.3 PARAMETERS SETTING: ARC FORCE

POT3  Using the potentiometer, edit the value of the setting.

PARAMETER	MIN	DEFAULT	MAX
ARC FORCE	0 %	- %	200 %

4.6 DC TIG WELDING

SEL1 Select the following welding mode on the selector located in the spool compartment: DC TIG

 TIG The message appears on the following displays: D2

4.6.1 PARAMETERS SETTING: WELDING CURRENT

E1  Using the potentiometer, edit the value of the parameter.

 The value appears on the following display: D1

PARAMETER	MIN	DEFAULT	MAX
WELDING CURRENT	10 A	80 A	250 A

4.6.2 PARAMETERS SETTING: POST GAS TIME

S1  Hold down the button for 3 seconds to open the menu.

 The acronym relative to the setting to be edited appears on the following displays: D1

 The value relative to the selected setting appears on the following displays: D2

POT3  Using the potentiometer, edit the value of the selected setting.

 Press any button to save the setting and quit the menu.

ACRONYM	PARAMETER	MIN	DEFAULT	MAX
Po.G.	POST GAS TIME	0.0 s	3.0 s	10.0 s

4.7 MIG/MAG WELDING

SEL1 Select the following welding mode on the selector located in the spool compartment: MIG/MAG

4.7.1 PARAMETERS SETTING: MIG/MAG WELDING VOLTAGE

- POT3  Using the potentiometer, edit the value of the parameter.
The value is saved automatically.

PARAMETER	MIN	DEFAULT	MAX
MIG/MAG WELDING VOLTAGE	10.0 V	-	40.0 V

4.7.2 PARAMETERS SETTING: WIRE FEED RATE





- POT2  Using the potentiometer, edit the value of the parameter.
The value is saved automatically.

PARAMETER	MIN	DEFAULT	MAX
WIRE FEED RATE	1.0 m/min		20.0 m/min

4.7.3 PARAMETERS SETTING: INDUCTANCE SETTING

- POT1  Using the potentiometer, edit the value of the parameter.

4.7.4 PARAMETERS SETTING: POST GAS TIME

- S1  Hold down the button for 3 seconds to open the menu.
 The acronym relative to the setting to be edited appears on the following displays: D1
 The value relative to the selected setting appears on the following displays: D2
POT3  Using the potentiometer, edit the value of the selected setting.
 Press any button to save the setting and quit the menu.

ACRONYM	PARAMETER	MIN	DEFAULT	MAX
Po.G.	POST GAS TIME	0.0 s	3.0 s	10.0 s





4.7.5 PARAMETERS SETTING: SPEED LIMIT

Set the welding power source ON/OFF switch to "O" to switch the unit off.

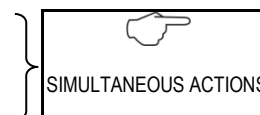
- S2  Hold down the button.

Set the welding power source ON/OFF switch to "I" to switch on the unit.



-  The acronym relative to the setting to be edited appears on the following displays: D1
 The value relative to the selected setting appears on the following displays: D2
POT3  Using the potentiometer, edit the value of the selected setting.
 Press any button to save the setting and quit the menu.

ACRONYM	PARAMETER	MIN	DEFAULT	MAX
SP.L.	SPEED LIMIT	1.0 m/min	20.0 m/min	20.0 m/min



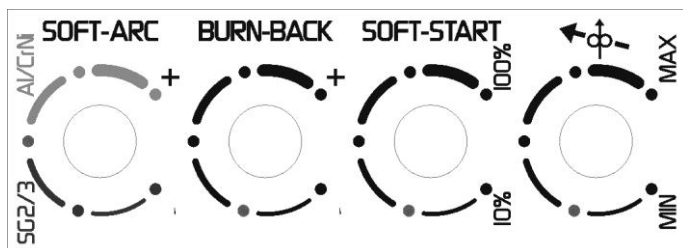

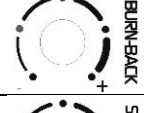
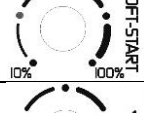
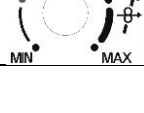

4.7.6 ADJUSTMENT WELDING PARAMETERS PANEL



The picture shows the adjustment panel of MIG/MAG welding parameters, accessible by opening the wire feeding unit door. If the panel is not enabled, the microprocessor automatically assigns the default value to the parameters.

	PARAMETER	MIN	DEFAULT	MAX
	SOFT-ARC	10 A	30 A	50 A
	BURN-BACK	0 ms	30 ms	100 ms
	SOFT-START	10 %	30 %	100 %
	MOTOR SLOPE	0 ms	0 ms	200 ms

5 TECHNICAL DATA

Directives applied	2002/96/EC-Waste electrical and electronic equipment (WEEE)		
	2004/108/EC-Electromagnetic compatibility (EMC)		
	2006/95/EC-Low voltage (LVD)		
Construction standards	2011/65/EU-Restriction of the use of certain hazardous substances (RoHS)		
	EN 60974-1; EN 60974-5; EN 60974-10 Class A		
Conformity markings		Equipment compliant with European directives in force	
		Equipment suitable in an environment with increased hazard of electric shock	
		Equipment compliant with directive 2002/96/EC-(WEEE)	
		Equipment compliant with directive 2011/65/EU-(RoHS)	
Supply voltage	3 x 400 Va.c. ± 15 % / 50-60 Hz		
Mains protection	16 A Delayed		
Z _{max}	If this equipment is connected to a public low voltage system, it is the responsibility of the installer or user of the equipment to ensure, by consultation with the distribution network operator if necessary, that the equipment may be connected.		
Dimensions (L x D x H)	410 x 270 x 355 mm		
Weight	19.0 kg		
Insulation class	H		
Protection rating	IP23S		
Cooling	AF: Air-over cooling (fan assisted)		
Maximum gas pressure	0,5 MPa (5 bar)		
Motor speed	1.0 - 20.0 m/min		
Wire spool: (dimensions/weight)	200 mm / 5 kg		
Static characteristic	MMA	 Drooping characteristic	
	TIG	 Drooping characteristic	
	MIG/MAG	 Flat characteristic	
Current and voltage adjustment range	MMA	10 A / 20.4V - 250 A - 30.0 V	
	TIG	10 A / 10.4 V - 250 A - 20.0 V	
	MIG/MAG	5 A / 14.2 V - 300 A - 29.0 V	
Welding current / Working voltage	MMA	40 % (40° C)	250 A - 30.0 V
		60 % (40° C)	220 A - 28.8 V
		100 % (40° C)	190 A - 27.6 V
	TIG	50 % (40° C)	250 A - 20.0 V
		60 % (40° C)	240 A - 19.6 V
		100 % (40° C)	210 A - 18.4 V
	MIG/MAG	35 % (40° C)	300 A - 29.0 V
		60 % (40° C)	230 A - 25.5 V
		100 % (40° C)	200 A - 24.0 V
Maximum input power	MMA	40 % (40° C)	8.7 kVA - 8.4 kW
		60 % (40° C)	7.3 kVA - 7.0 kW
		100 % (40° C)	6.1 kVA - 5.8 kW
	TIG	50 % (40° C)	6.1 kVA - 5.8 kW
		60 % (40° C)	5.8 kVA - 5.5 kW
		100 % (40° C)	4.8 kVA - 4.5 kW
	MIG/MAG	35 % (40° C)	10.3 kVA - 9.7 kW
		60 % (40° C)	6.9 kVA - 6.5 kW
		100 % (40° C)	5.8 kVA - 5.5 kW
Maximum supply current	MMA	40 % (40° C)	12.7 A
		60 % (40° C)	10.6 A
		100 % (40° C)	8.8 A
	TIG	50 % (40° C)	8.8 A
		60 % (40° C)	8.3 A
		100 % (40° C)	6.8 A
	MIG/MAG	35 % (40° C)	15.0 A
		60 % (40° C)	10.0 A
		100 % (40° C)	8.4 A

ENGLISH

Maximum effective supply current	MMA	40 % (40° C)	8.0 A
		60 % (40° C)	8.2 A
		100 % (40° C)	8.8 A
	TIG	50 % (40° C)	6.2 A
		60 % (40° C)	6.4 A
		100 % (40° C)	6.8 A
	MIG/MAG	35 % (40° C)	8.8 A
		60 % (40° C)	7.7 A
		100 % (40° C)	8.4 A
No-load voltage (U₀)	MMA	53 V	
	TIG	53 V	
	MIG/MAG	53 V	

6 SPARE PARTS

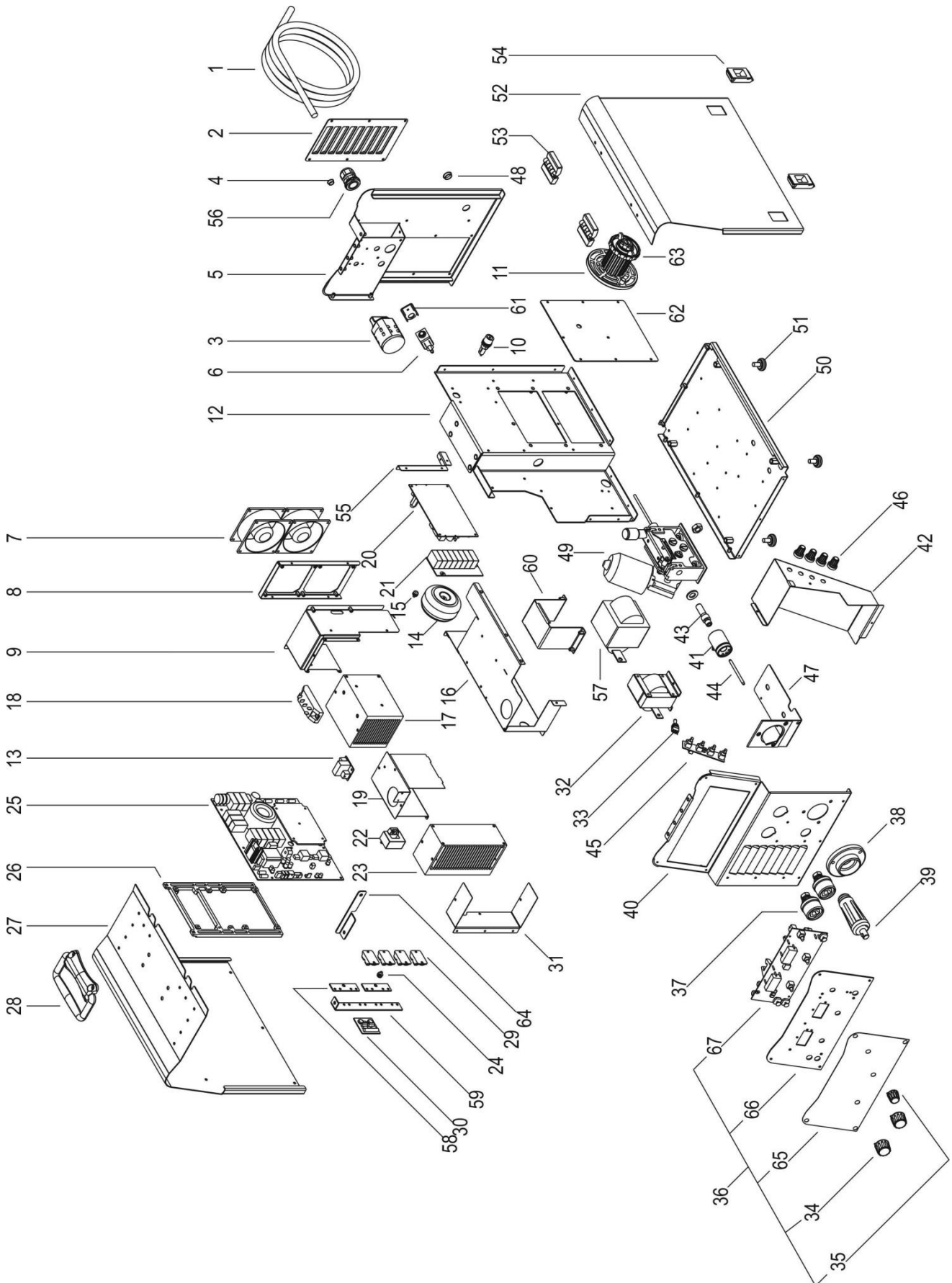

ENGLISH

N°	CODE	DESCRIPTION
1	045.0002.0005	SUPPLY CABLE
2	011.0009.0119	FAN COVER REAR PLATE
3	040.0001.0015	THREE-POLE SWITCH
4	016.0011.0007	CAP Ø= 11
5	011.0009.0103	REAR PLATE
6	017.0001.5542	SOLENOID VALVE
7	003.0002.0015	FAN
8	011.0009.0102	FAN SUPPORT
9	011.0009.0110	INTERNAL FAN SUPPORT
10	040.0006.1880	FUSE CARRIER
11	011.0006.0050	SPOOL SUPPORT
12	011.0009.0104	INTERNAL PLATE
13	050.0001.0084	FAN CONTROL BOARD
14	041.0006.0005	AUXILIARY TRANSFORMER
15	040.0003.1003	THERMAL CUT-OUT
16	011.0009.0107	INTERNAL SUPPORT
17	015.0001.0014	HEAT SINK
18	032.0001.8215	THREE PHASE BRIDGE RECTIFIER
19	011.0009.0108	INTERNAL CONVEYOR
20	050.0001.0041	MOTOR BOARD
21	050.0001.0040	PRIMARY CAPACITOR BOARD
22	041.0004.0301	HALL EFFECT SENSOR
23	015.0001.0013	SECONDARY HEAT SINK
24	040.0003.1007	THERMAL CUT-OUT
25	050.0001.0091	POWER BOARD
26	012.0003.0000	INTERNAL FRAMEWORKS
27	011.0000.0685	COVER PLATE
28	011.0006.0031	HANDLE
29	032.0002.2003	ISOTOP DIODE
30	050.1503.0044	SNUBBER BOARD
31	011.0009.0109	FRONTAL CONVEYOR
32	044.0004.0013	INDUCTANCE
33	022.0002.0127	SWITCH + CABLE
34	014.0002.0004	KNOB WITH POINTER
35	014.0002.0008	KNOB WITH POINTER
36	050.5063.9900	LOGIC FRONT PANEL
37	021.0001.0259	FIXED SOCKET
38	021.0001.2005	PLASTIC HOUSING
39	022.0002.0005	MOVABLE PLUG
40	011.0009.0106	FRONT PLATE
41	021.0001.2001	AXIAL EURO BODY
42	011.0009.0105	LOGIC PROTECTION PLATE
43	021.0001.2011	STING
44	021.0001.2021	CAPILLARY TUBE
45	050.0001.0077	POTENTIOMETERS BOARD
46	014.0002.0021	KNOB WITH POINTER
47	011.0009.0120	MOTOR SUPPORT PLATE
48	016.0011.0009	CAP Ø= 16
49	010.0008.0002	WIRE FEED MOTOR
50	011.0009.0100	LOWER COVER
51	016.0009.0003	RUBBER FOOT
52	011.0000.0692	DOOR PLATE
53	011.0006.0006	PLASTIC HINGE
54	011.0006.0002	SLIDE CLOSURE
55	011.0009.0112	REAR FIXING PLATE
56	045.0000.0007	CABLE CLAMP
57	042.0003.0003	POWER TRANSFORMER
58	045.0006.0053	COPPER BRACKET (POSITIVE POLE)
59	045.0006.0052	COPPER BRACKET (NEGATIVE POLE)
60	011.0009.0121	TRANSFORMER SUPPORT PLATE
61	011.0002.0018	SOLENOID VALVE PLATE
62	011.0009.0127	INTERNAL PLATE
63	002.0000.0284	SCREW CAP FOR SPOOL SUPPORT
64	045.0006.0080	FRONT FIXING PLATE
65	013.0007.0747	FRONT PANEL LABEL
66	013.0000.8009	LOGIC BOARD PLATE
67	050.0002.0082	LOGIC BOARD

6.1 WIRE FEED MOTOR

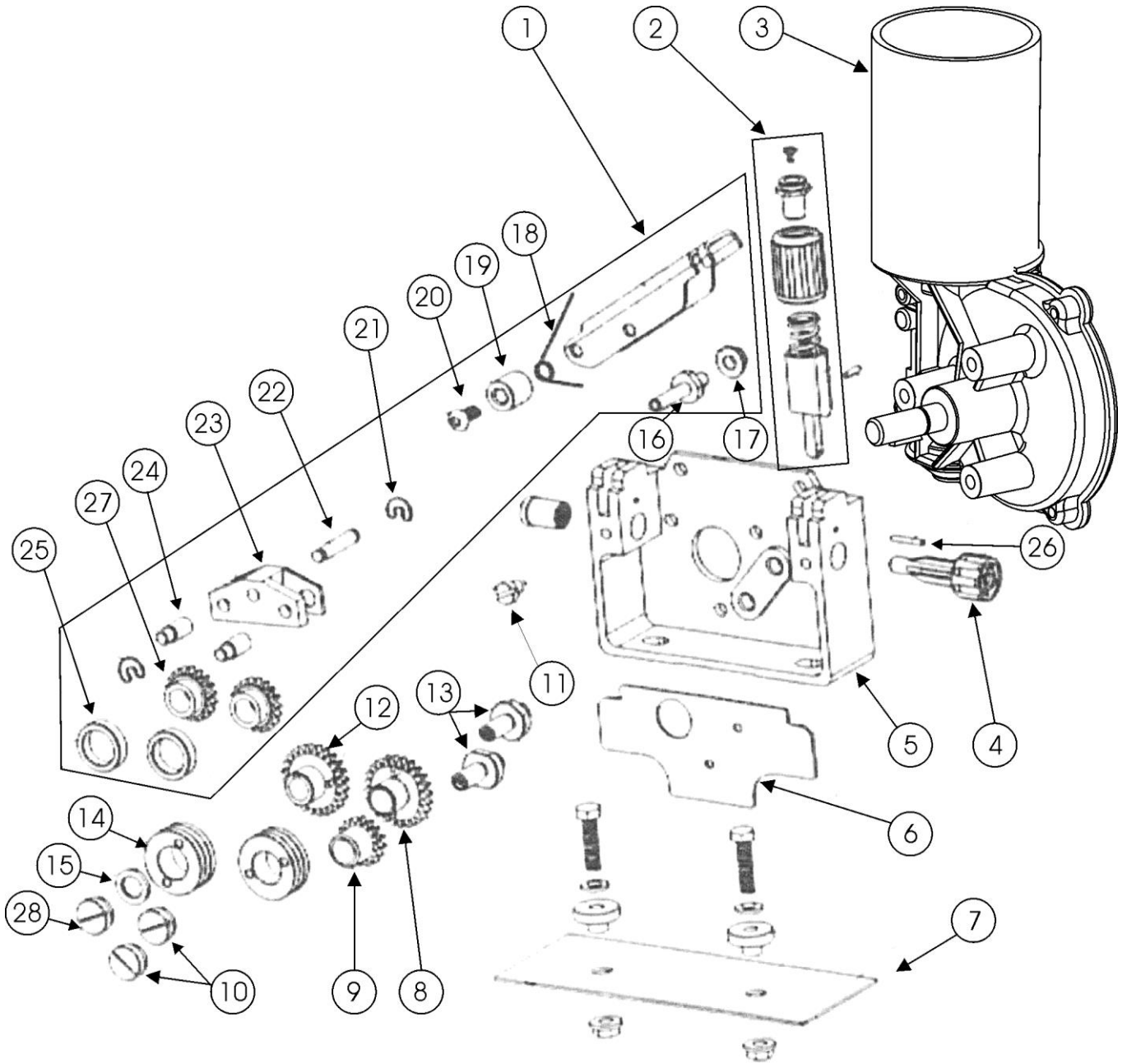

N°	CODE	DESCRIPTION
1	002.0000.0205	COMPLETE PRESSURE ARM
2	002.0000.0203	COMPLETE PRESSURE DEVICE
3	002.0000.0201	MOTOR COIL
4	002.0000.0259	INLET GUIDE WITH SOFT LINER
5	002.0000.0202	FEED PLATE
6	002.0000.0266	GUARD SAFETY KIT
7	002.0000.0212	INSULATION MOUNTING KIT
8	002.0000.0209	GEAR ADAPTOR FEED ROLL
9	002.0000.0210	MAIN GEAR DRIVE
10	002.0000.0207	SCREW
11	002.0000.0208	SCREW
12	002.0000.0211	GEAR ADAPTOR FEED ROLL
13	002.0000.0255	SHAFT
14	002.0000.0121	FEED ROLL
15	002.0000.0270	WASHER
16	002.0000.0269	PRESSURE ARM HOLDER AXIS
17	002.0000.0271	SCREW
18	002.0000.0272	SPRING PRESSURE ARM AUTO LIFT
19	002.0000.0273	SPACE TUBE PRESSURE ARM AUTO-LIFT
20	002.0000.0274	SCREW
21	002.0000.0275	CIRCLIP
22	002.0000.0276	LOCATING PIN PRESSURE ARM
23	002.0000.0277	HOLDER
24	002.0000.0278	AXLE GAUGE
25	002.0000.0279	PRESSURE ROLL
26	002.0000.0280	LOCATING PIN PRESSURE DEVICE
27	002.0000.0281	GEAR ADAPTOR
28	002.0000.0282	DRIVING FEED ROLL

6.2 WIRE FEEDER ROLLS

D = 30 mm
d = 14 mm

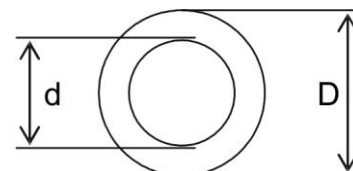

N°	CODE	WIRE DIAMETER	GROOVE TYPE
	0.6 - 0.8	002.0000.0119	
	0.8 - 1.0	002.0000.0120	V groove Solid wire
	1.0 - 1.2	002.0000.0121	
	1.2 - 1.6	002.0000.0125	
14	1.0 - 1.2	002.0000.0124	VK shape Flux-cored wire
	1.2 - 1.6	002.0000.0127	
	0.8 - 1.0	002.0000.0122	U shape Aluminium wire
	1.0 - 1.2	002.0000.0123	
	1.2 - 1.6	002.0000.0126	

7 ELECTRICAL DIAGRAM

7.1 MICROMAG 301 PLUS

