



USER MAINTENANCE MANUAL
MW 8100 Portable Welding Fume Extractor
110V









MasterWeld thanks you for purchasing a product from its range and invites you to read this booklet. Inside you will find all the information necessary for the correct use of the purchased machine; therefore, please carefully follow the instructions contained therein and read all the parts. Please also keep the booklet in a suitable place to keep it unaltered. The content of this booklet can be modified without notice or further obligations, in order to include changes and improvements to the units already sent. The reproduction or translation of any part of this booklet without the written consent of the owner is prohibited.

Warnings:

	CAREFULLY READ THIS USE AND MAINTENANCE MANUAL IN ITS ENTIRETY.
	IN CASE OF NEED, CONTACT ONLY OUR LOCAL AUTHORIZED DEALER.
	THE PRODUCT HAS BEEN TESTED ACCORDING TO THE CURRENT EUROPEAN DIRECTIVES

Symbology and Staff:

Below is a brief legend with an indication of the symbols used (the symbols indicated are those most used in this booklet; the remaining symbols are however easy to understand).

	ELECTRIC RISK: draws attention to dangerous situations in which accidental contact with ELECTRIC parts is possible, with consequent harm to the person.
	HIGH TEMPERATURE: draws attention to a dangerous situation resulting from the high temperatures reached by some parts of the machine during operation.
	DANGER: draws attention to situations or problems that can affect the safety of people due to injury or risk of death.
	ATTENTION: draws attention to situations and problems associated with the efficiency of the machine that do not affect the safety of people.
	IMPORTANT: draws attention to important information of a general nature that does not affect personal safety or the proper functioning of the machine.
	ENVIRONMENT: draws attention to behaviors and procedures to limit the environmental impact related to the use of the machine.
U	USER: means the end user of the machine or an employee who has received specific training on the use and maintenance of the same.
PQ	QUALIFIED STAFF: means personnel who professionally carry out activities relating to plant engineering such as, for example, electrician, plumber, installer, etc.
TA	AUTHORIZED TECHNICIAN: means specialized technical personnel, authorized by MasterWeld to intervene on the machine (see "Contacts and Numbers").

Images and Representations:

The images and figures used in this booklet are to be considered purely indicative and may have some differences compared to the unit sent. MasterWeld reserves the right to modify the machine without notice.



It should be noted that for reasons of visibility and clarity, some images represent the machine without protections or with an incorrect configuration.



MW 8100

Safety Warnings:

Working environment



Do not use the machine in places where there is a risk of explosion or fire. Do not approach the machine with open flames or other.

Use the machine in a dry environment, not subject to condensation phenomena of atmospheric humidity and protected from direct exposure to atmospheric agents and sunlight.

Always use the machine in adequate lighting conditions. The environment of use must be well ventilated and in compliance with the regulations in force on hygiene and safety at work.

Do not use the machine in harsh environmental conditions: the ambient temperature must be between 5 ° C and 40 ° C, with a humidity level less than 80%.

Preliminary Checking



Check that the electrical power supply system of the machine is up to standard and equipped with appropriate protection devices against current leakage and short circuit.

The use of the product must be preceded by adequate staff training and by reading this Use and Maintenance Manual.

Use and maintenance



The machine can be used as a portable unit for the extraction, filtration and deodorization of welding fumes in the electronics industry in general, in body shop departments and for small welds.

The use of the machine is allowed only to adult and responsible operators, properly trained.

The machine must be handled with caution, respecting the rules given in this booklet.

After use, do not leave the flexible hose unattended on the ground, as it could get in the way or be damaged.

Handle the tube and the cap using protective gloves in order to avoid burns due to the high temperatures that can be reached in conditions of prolonged use.

Do not carry out repairs or modifications to the machine, unless authorized by MasterWeld Do not carry out maintenance when the machine is running. To clean the machine, do not use corrosive or harmful detergents to people's health.

In case of breakdown or malfunction of the machine DO NOT USE IT AND WRITE IT CLEAR THAT IS OUT OF THE SERVICE. Contact our Technical Assistance for any repairs.



Wear suitable personal protective equipment (PPE) during use, maintenance and cleaning of the machine.



During the maintenance phases, do not disperse any residues in the surrounding environment, but comply with the current regulations.

Failure to comply with the warnings may compromise the safety of the product

Responsibility of the Producer:

The manufacturer MasterWeld declines all responsibility deriving from improper or incorrect use of the machine, from damage caused by the use of non-original spare parts, from the consequences deriving from maintenance operations not carried out correctly or from tampering with the product, its control circuits or system software.

The technical staff responsible for managing the machine and / or the related suction system is responsible for applying the safety requirements contained in this booklet; must verify that the personnel assigned to use the machine are qualified to carry out the required activity and are properly informed about the risks associated with it; he must also scrupulously monitor compliance with the provisions contained in this document and with the general safety standards applicable to the machine.

Failure to comply with the safety rules can cause damage and injury, even serious, to personnel and irreparably damage the product.

Certifications:

The machine has been manufactured in compliance with the relevant Community Directives applicable at the time of its placing on the market:

- 2006/42 / EC "Machinery Directive" of 17 May 2006
- 2014/35 / EU "Low Voltage Directive (LVD)" of 26 February 2014
- 2014/30 / EU "Electromagnetic Compatibility Directive (EMC)" of 26 February 2014
- 2011/65 / EU "RoHS Directive" of 8 June 2011

According to the Machinery Directive 2006/42 / EC, the product is configured as a "partly completed machine", therefore it cannot be put into service separately from the suction system that completes it; for this reason, the Declaration of Conformity, according to Directive 2006/42 / EC, can only be applied to the complete system, at the end of its installation.

The product complies with the 2014/35 / EU, 2014/30 / EU, 2011/65 / EU directives and subsequent amendments and complies with the applicable minimum safety requirements (RES) of the 2006/42 / EC directive, as certified by the Declaration of Conformity that accompanies it and that is reported in the following of this Use and Maintenance Manual.

DECLARATION OF CONFORMITY
Directives 2006/42 / EC, 2014/35 / UE, 2014/30 / UE, 2011/65 / UE

In the person of our legal representative declares under our sole responsibility that the product:

PORTABLE EXHAUST FILTERING UNIT FOR WELDING FUMES

Model: **MW 8100**

to which this declaration refers complies with the provisions of directives **2014/35 / EU, 2014/30 / EU, 2011/65 / EU** and subsequent amendments and additions.

We also specify that:

- The year of manufacture is shown on the label (with CE mark) placed on the machine.
- The serial number is reported directly on the machine.

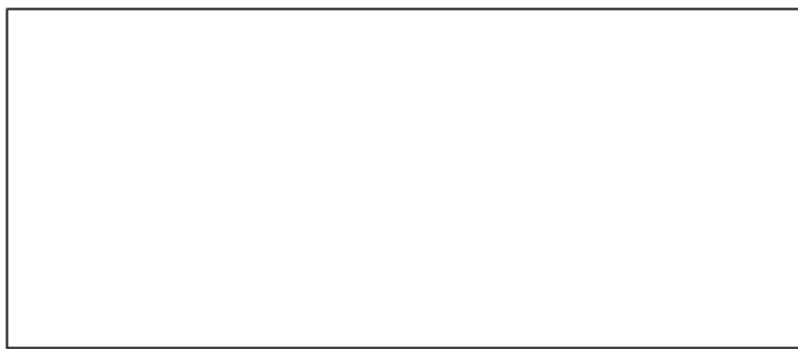

General index

<i>Warnings:</i>	2
<i>Symbology and Staff:</i>	2
<i>Images and Representations:</i>	2
<i>Responsibility of the Producer:</i>	5
<i>Certifications:</i>	5
1. Introduction	8
1.1 Product Description.....	8
1.2 Final Use	9
1.3 Not authorised use.....	9
1.4 Residual Risks	10
1.5 Safety Stickers.....	10
1.6 Documentation.....	11
1.7 Warranty.....	11
2. TECHNICAL DATA.....	12
2.1 Technical data	12
3. delivery transport and installation	13
3.1 Preliminary Checks.....	13
3.2 Transport and Handling	13
4. general rules of use	14
4.1 Preliminary Checks.....	14
4.2 How to use.....	14
For a correct use of the machine you must:	14
5. maintenance	15
5.1 Ordinary Maintenance.....	15
5.2 Replacing the filters: preliminary indications	15
5.2.1 Replacing the Cartridge Filter.....	16
5.2.2 Replacing the Activated Carbon Filter	16
5.2.3 Replacement of protection fuses	17
6. end of use	18
6.1 Preliminary Operations	18
6.2 Machine Demolition	18
7. spare parts	19
7.1 SPARE PARTS LIST	19
8. WIRING DIAGRAM	20
8.1 MW 8100	Error! Bookmark not defined.
9. PROBLEMS, causes, SOLUTIONS	21

1. INTRODUCTION

1.1 Product Description

The MW 8100 machine described in this booklet is a portable unit for the extraction, filtration and deodorization of welding fumes in the electronic industry in general, in bodywork departments and for small welding.

Polluted air is sucked in by a brush motor with integrated aspirator positioned inside the machine casing. Captured is done by an adjustable cap and through a 60mm diameter flexible tube reaches a filtration cartridge. After the fan fume will be finally expelled. The final deodorization is carried out through an activated carbon cell.

The main components of the machine are listed below:

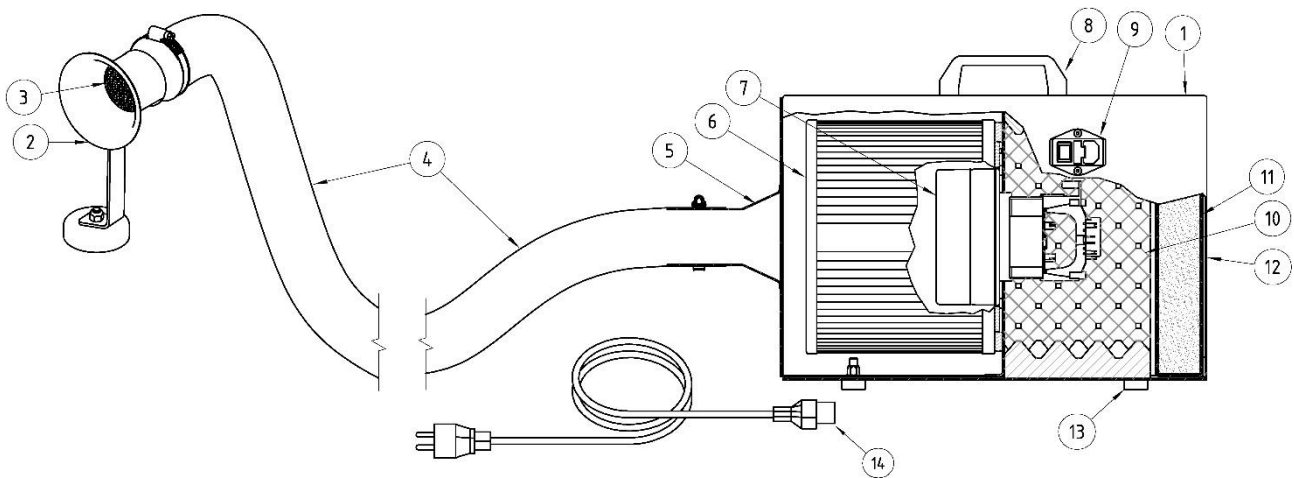

1. Machine carpentry
2. Adjustable suction hood
3. Anti-spark brass cloth
4. Flexible hose
5. Suction flange
6. Filter cartridge
7. Brush motor
8. Handling handle
9. Socket with switch and fuses
10. Internal soundproof KIT
11. Activated carbon cell
12. Expulsion flange
13. Lower feet
14. Power cable

1.2 Final Use



The MW 8100 machine, produced by MasterWeld, is equipment designed for the extraction, filtration and deodorization of tin welding fumes in the electronic industry and in general the fumes from small welds in bodyshop and in mechanical workshops.

1.3 Not authorised use



The intended use of the machine is the suction of welding fumes in industry and body shop: it is forbidden to use it to suck up other substances (dust, liquids, vapors, etc.), especially if flammable, explosive, corrosive other than those commonly contained in the emissions of a motor vehicle.

The machine must only be used in a work environment protected from atmospheric agents.

The machine must be used with caution, making sure that the power supply cable and flexible hose are not placed in dangerous areas or where they can hinder other operators.

MasterWeld declines all responsibility for damage to things or people deriving from improper use of the machine.



The machine was not designed to be used in a potentially explosive atmosphere: its use in environments where there is a risk of fire or explosion is prohibited.

If you need to install the machine in an environment whose atmosphere is potentially explosive, it is recommended to contact MasterWeld in advance.



The nozzle must allow the entry of air at room temperature in a ratio of 1: 1 with the aspirated fumes. This is necessary to lower the average temperature of the sucked gases, preserving the life of the internal components of the machine.

It is forbidden to use it with systems for capturing and conveying the flow rate that do not allow the entry of air at room temperature as prescribed.

MasterWeld disclaims any liability for damage to the machine itself, to people or property caused by the incorrect use of the collection cap or the use of inappropriate hoods.

1.4 Residual Risks

The Risk Analysis carried out by MasterWeld on the product and contained in the Technical File, made it possible to eliminate all the main sources of danger related to the use of the machine; however, there are some unavoidable risks that will be listed below:



ELECTRICAL RISK: It is forbidden to perform repairs or maintenance on the machine when it is connected to the electrical power system; however, should it be necessary to operate with the machine powered on, this practice can only be carried out by Qualified Personnel (PQ), with expertise in the electrotechnical field, or by an Authorized Technician (TA) appointed by MasterWeld

Adopt all the precautions according to the regulations in force if you have to operate with the machine powered on: wear insulating gloves and shoes and use insulating mats and insulated tools. Also check that the system to which the machine is connected is protected from leaks and short circuits, as required by current legislation

RISK OF FIRE OR EXPLOSION:

The machine cannot be used in environments with a high risk of fire or explosion. It is forbidden to store, even temporarily, potentially flammable or deflagrating substances in the rooms where the exhaust gas extraction system is installed.

RISK OF BURNS: During work operations, the machine, especially on the ejection side, can reach high temperatures with consequent risk of burns. Use heat-resistant gloves for handling the machine.

RISK OF FAILURE OR MALFUNCTIONING: Long use of the machine in particularly severe environmental conditions (brackish environment, excessive temperature, condensation, presence of dust, exposure to atmospheric agents, etc.), can cause malfunctions or failures of the product and compromise its safety.

Respect the requirements indicated in the "Safety Warnings" relating to the work environment, reported in this Use and Maintenance Manual.

RISK OF INCORRECT INTERPRETATION OF SAFETY ADHESIVES: Following the identification of the main sources of danger that emerged from the Risk Analysis, Safety Stickers, with unified symbols, were applied to the machine to signal these sources of danger. Over time, these stickers can become illegible or difficult to interpret due to aging or wear.



The user is required to immediately replace the Safety Stickers that should become illegible due to aging, wear or damage.



To limit these risks, it is recommended to comply with all the indications given in this Use and Maintenance Manual, not to force or inhibit the safety of the machine and to wear the personal protective equipment (PPE) provided.

Please note that all personnel involved in the use and maintenance of the machine and the plant in which it operates must be aware of the relevant safety standards.

1.5 Safety Stickers

On the machine are applied stickers bearing symbols and / or safety messages; their location and the nature of the danger reported are indicated below.

SYMBOL	DESCRIPTION	
	<p align="center">RISK OF ELECTRIC SHOCK</p> <p>The machine's power socket (fig. 1) and the power cable are subject to the risk of electrocution due to the presence of electric parts.</p> <p align="center">It is forbidden to touch all electric parts.</p> <p>It is strictly forbidden to extinguish fires using water, due to the presence of electric parts.</p>	

	<p>RISK OF BURNS FROM CONTACT WITH HOT SURFACES</p> <p>During normal work operations the machine casing, especially on the ejection side, and the activated carbon filter can reach temperatures above 60 ° C with consequent risk of burns.</p> <p>There is an obligation to use appropriate personal protective equipment (PPE)</p>	
---	--	---



It is absolutely forbidden to remove the Safety Stickers and the Identification Plate on the machine and / or its components. MasterWeld declines any responsibility related to the safety of the machine in case of non-compliance with this prohibition.

Make sure that the safety stickers are intact and legible; for cleaning, do not use solvents, alcohol or petrol. Replace the illegible plates by requesting a new one from MasterWeld

1.6 Documentation

The MW 8100 machine is accompanied by this User and Maintenance Booklet which contains the technical information, figures, instructions and warnings necessary for correct use of the product.

The User and Maintenance Booklet must accompany the machine throughout its life cycle, even in the event of sale or transfer; must be stored in such a way as to ensure its integrity and must be easily accessible in case of need (it is advisable to keep a copy near the machine).

The purpose of this document is the transmission of the information necessary for the competent and safe use of the product and therefore must be made available to all personnel who work with the machine and its systems (Plant Manager, User, Maintenance Technician and Qualified Personnel machine installation, power supply and commissioning). In the event that this manual is lost or damaged, it is recommended to request a new copy directly from MasterWeld

The technical information, illustrations and diagrams contained in this document are the property of MasterWeld and must be considered confidential.

1.7 Warranty

The duration of the guarantee is

- 12 months from the date of purchase for all non-electrical components
- 6 months from the date of purchase for electrical components

The guarantee only gives the right to replace the original defective parts. However, the warranty is excluded if the devices are improperly used or tampered with by persons not authorized by us or in any case using non-compliant components or techniques. The use of non-original spare parts immediately voids the warranty. The warranty covers only the parts of the machine built or assembled by MasterWeld

Components subject to wear, consumables and all filter elements are excluded from the guarantee.

2. TECHNICAL DATA

2.1 Technical data

The MW 8100 machine described in this booklet is a portable unit for the extraction, filtration and deodorization of welding fumes in the electronic industry in general, in body shop departments and for small welds.

For the dimensions and weights of the machine, refer to the technical data sheet "110.00.ST001", supplied. The suction of welding fumes is guaranteed by a brush motor with integrated fan

	<p>The hood must allow the entry of air at room temperature at a ratio of 1: 1 with the welding smoke. This is necessary to lower the average temperature of the sucked gases, preserving the life of the internal components of the machine.</p> <p>MasterWeld disclaims any responsibility for damage to the machine itself, to persons or property caused by the incorrect use of the collection hood or the use of inappropriate hoods.</p>
---	--

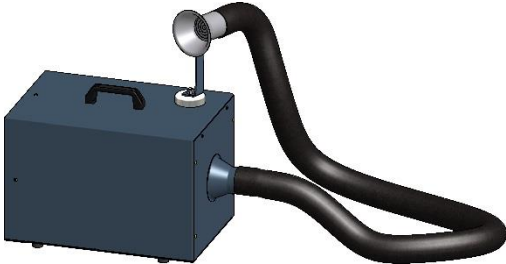
MW 8100			
	Supply voltage	[V/Hz]	230/50
	Engine power	[W]	1100
	Weight	[Kg]	18
	Max.flow rate	[m3/h]	163
	Max.pressure drop	[mmH2O]	663
	Sound level	[dBA]	73
	Diam.of flexible hose	[mm]	60
	Length of flexile hose	[mm]	3000
	Diam.of hood	[mm]	110
	Filtering material	[-]	Cellulose
	Filtering surface	[m2]	1,12
	Dust classification	[-]	"M"
	BIA classification	[-]	USGC
	Active carbon quantity	[Kg]	2

2.2 Technical Characteristics of Flexible Piping

The flexible hose supplied with the machine has the following characteristics:

	Nominal diam.	Hose length	Bending radius	Weight per kg	Using temp.	Max temp.
	DN [mm]	L [m]	R [mm]	[Kg]	T [°C]	T [°C]
MW 8100/TUBO	60	3	42	0.17	90	120 (*)
(*) the temperature of 120 ° C is intended for peaks with a maximum 15s						

	<p>MasterWeld declines all responsibility for damage to the machine itself, to people or things caused by the use of unsuitable pipes</p>
---	--

3. DELIVERY TRANSPORT AND INSTALLATION

3.1 Preliminary Checks

Upon delivery, the machine is contained in a single package. Upon receipt of the goods, check that the packaging is integrate and that there are no signs of possible damage suffered during transport; if necessary, before opening the package, document the problems encountered with some photographs.

In the event that the product is damaged, do not proceed with its implementation and report the incident to MasterWeld to agree with the same the actions to be carried out.

Arrange a place protected from bad weather to store the product waiting for the installation, in case installation is not immediate.



The product cannot be exposed to bad weather, its storage and use must therefore be foreseen within a specially protected room.

In case of damage to the product during transport, do not proceed with use and contact our local Authorized Dealer or our Technical Assistance Service.

3.2 Transport and Handling

For the transport operation, the operator must unload the packaged machine using a suitable means for lifting.

Remove the packaging only at the time of final commissioning of the machine and dispose of the materials in accordance with current regulations.



The loading and unloading operations and subsequent handling must be performed keeping the machine in its original packaging and using an appropriate lifting device.

Make sure that the lifting means are suitable for the weight of the machine (weights and dimensions of the product are shown in the technical data sheet "110.00.ST001" supplied), and carry out handling in safe conditions, in accordance with the provisions of current legislation.

Personnel not involved in the operation must keep a safe distance. Check that there are no objects resting on the machine and that the moving parts have been fixed. The floor must be flat, clean and free of residues

When opening the packaging, the operator must

- Check that all machine components are present and that they have not been damaged during transport. If not, contact our dealer.
- Connect the flexible suction hose to the machine's suction duct and secure it using the hose clamp supplied.
- Assemble the handle of the machine using the 2 screws supplied and a No. 6 Allen key.



Do not leave the packaging elements (cellophane, wood, cardboard, etc.) within the reach of children, as they are potential sources of danger

Do not dispose of the packaging materials in the environment. The packaging must be done in accordance with the regulations.

4. GENERAL RULES OF USE

4.1 Preliminary Checks

- This machine must only be used for the use for which it was expressly designed. Any other use is to be considered improper and therefore dangerous. MasterWeld cannot be held responsible for any damage deriving from improper, erroneous and unreasonable use.
- Before connecting the machine, make sure that the plate data correspond to those of the electrical distribution network.
- The execution of the electrical system must comply with current regulations.
- If you decide to no longer use the machine described in this Use and Maintenance Manual, it is recommended to render it inoperative by disconnecting it from the power supply and disposing of it in accordance with the regulations in force in the country of use.
- If the machine is accidentally dropped or is subjected to violent blows, it can have even invisible damage and become dangerous, therefore do not use it but have it checked immediately by our technical assistance.

4.2 How to use

For a correct use of the machine you must:

- Position the machine near the source of the polluting fumes, using the handle provided.
- Position the suction cap of the machine at the point where you want to perform the suction using the magnetic base supplied.
- Connect the supplied cable to the machine's power socket (in the Figure)
- Insert the plug into a suitable electrical socket (check in advance the correspondence of the power supply values with those of the machine, shown both in this Use and Maintenance Manual, and in correspondence with the machine);
- Press the machine switch bringing it to position "1". The switch is located on the left side of the machine when looking at it from the activated carbon side (ejection flange). The switch itself will light up.
- At the end of the processing phases, press the machine switch bringing it to the "0" position. The switch will turn off (fig. 3).
- Disconnect the electric plug from the power socket and if necessary also disconnect the electric cable from the power socket on the machine; position the machine in such a way as not to cause obstacles and / or problems and in such a way that it is not a source of danger to normal activities.



At the end of its use, do not leave the hose and the power cable on the ground as they could get in the way or be damaged.



Wear heat resistant gloves to prevent burns from high temperatures that can reach the suction cap and hose.

5. MAINTENANCE

5.1 Ordinary Maintenance

The machine requires the ordinary maintenance operations listed below, to be performed periodically by the personnel defined in the right column:

Intervention:	Frequency	Staff:
Visual check of the condition of the flexible hoses	Annual	U
Check the correct tightening of the hose clamps	Annual	U
Check the status of the power cables	Annual	U
Visual check of the state of the power socket with switch	Annual	U
Visual check of the filter status. Filters are not regenerable	Bimonthly	U
Cartridge filter replacement	Half yearly	PQ
Replacement of Non-sparking brass cloth	Half yearly	PQ
Replacement of Active carbon filter	Annual	PQ

NOTE: The frequency indicated for maintenance interventions is purely indicative and refers to standard conditions of use. If the machine is used in particular conditions or in a particularly harsh environment, contact our Technical Assistance Service.



All maintenance operations must be performed with the machine not in operation and disconnected from the power supply.



During the maintenance of the machine wear personal protective equipment (PPE) specific for the operations to be performed: Gloves, Goggles and Face filter mask

5.2 Replacing the filters: preliminary indications

With use, the suction capacity of the machine tends to decrease as a result of the progressive clogging of the filters. They are not regenerable and must be periodically replaced.

NOTE: The periodicity indicated in paragraph **5.1 Ordinary Maintenance** for replacing the filters is purely indicative and refers to standard conditions of use. If the machine is used in particular conditions or in a particularly harsh environment, contact our Technical Assistance Service.



ATTENTION: The machine could contain dusts which are harmful to health. Repair, maintenance, filter replacement cleaning operations must be carried out by suitably trained personnel equipped with adequate personal protective equipment (PPE): Gloves, Goggles and Facial filter mask.



Do not disperse the filters used in the environment.
Deliver them to specialized disposal companies in accordance with current legislation.

5.2.1 Replacing the Cartridge Filter

The cartridge filter is located inside the carpentry of the machine on the side of the suction flange, fixed by means of a bayonet anchoring system. To replace it, follow the procedure below:

- Remove the Intake Flange, unscrewing the self-tapping screws indicated in Fig.1. Save the screws.
- Squeeze the filter and, keeping it squeezed, turn it clockwise until the bayonet hooks disengage (about 1.5cm) (Fig.2).
- Remove and set aside the filter which will then be disposed of.
- Position the new filter where the old one was, making sure that the 3 pins of the bayonet coupling system correctly engage the 3 dedicated keyhole slots (Fig. 3).
- Squeeze the filter and, keeping it squeezed, rotate it counterclockwise for about 1.5cm in order to send the pins of the bayonet system into the dedicated seat (Fig. 4).
- Check that the filter is correctly and firmly attached.
- Fix back the suction flange.

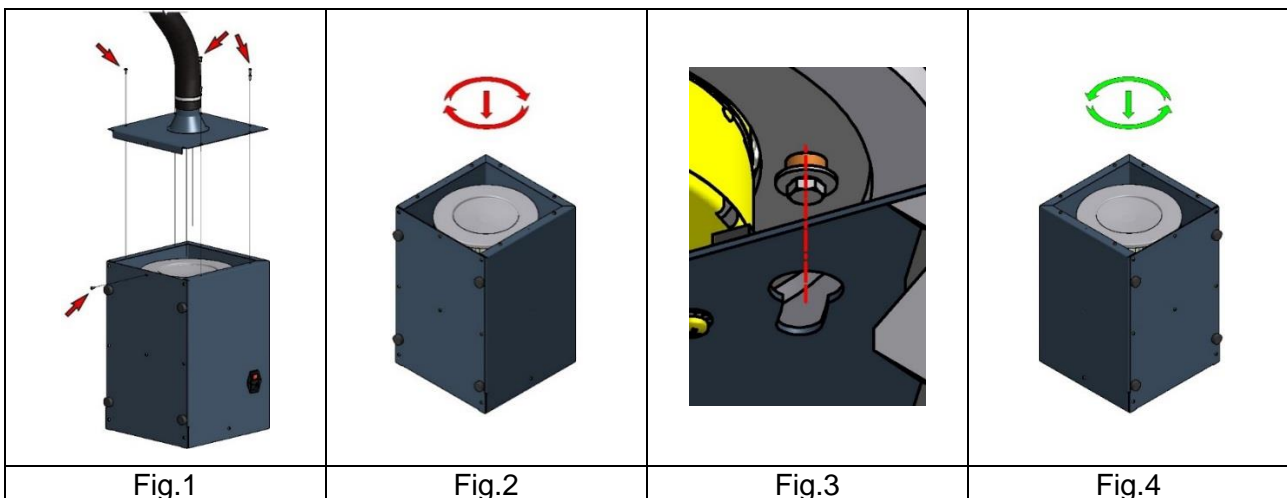

5.2.2 Replacing the Activated Carbon Filter

The activated carbon filter is positioned in view in the rear part of the machine, previously referred to as the ejection flange. To replace the filter, follow the procedure below:

- Remove and keep the 4 rubber feet and the fixing screws of the lower flange of the machine.
- Remove the filter fixing screws.
- Remove the filter from its seat and put it away: after you should take care of it;
- Place the new filter in place of the old one, making sure that the mousse gasket is facing the outside of the machine, abutting the sheet metal flange of the machine casing.
- Pressing the filter downwards in order to compress the mousse gasket, make 3 $\text{Ø}3.5$ holes on the 3 sides of the filter in correspondence with the slots on the machine casing.
- Apply 3 of the previously removed screws and lock the filter.
- Reassemble the lower flange of the machine fixing it with the screws previously removed.

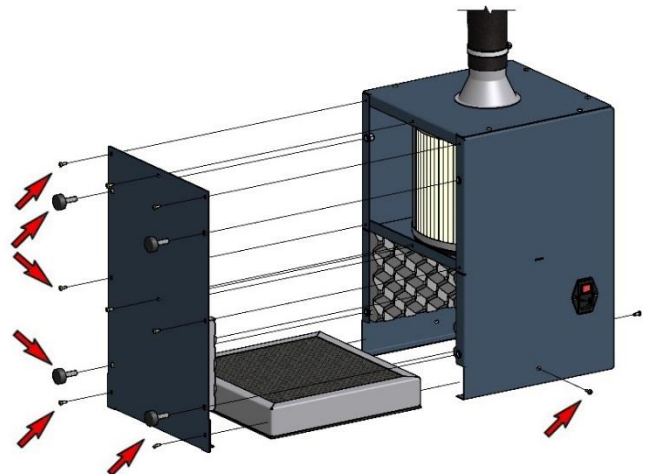

5.2.3 Replacement of protection fuses

The MW 8100 machine is powered by an electric socket which integrates a protection fuse which intervenes in the event of overloaded currents, safeguarding the suction brush motor and the machine itself.

If, following an overcurrent, the fuse blows, it must be replaced. Before this operation, however, it is necessary to verify what were the causes that led to the intervention. If they are internal to the machine, they will need to be removed / resolved before replacing them.

For the size of the fuse refer to the wiring diagram in par. 8



The operations to replace the protection fuses must be carried out by Qualified Personnel (PQ).

The replacement of the protection fuses must be performed with the machine not in operation and disconnected from the power supply.



The use of fuses of the wrong size, especially if oversized, can compromise the proper functioning of the machine and can damage it or some of its components.



IN CASE OF DOUBTS OR DIFFICULTIES, CONTACT OUR TECHNICAL ASSISTANCE SERVICE AND POSSIBLY REQUEST THE INTERVENTION OF AN AUTHORIZED MASTERWELD TECHNICIAN.

To replace the fuses, follow the instructions below:

- Remove the machine power cable from the power socket.
- Using a slotted screwdriver, remove the fuse holder as shown in Fig.1.
- Replace the fuse with one of the same size and type;
- Close the fuse holder by inserting it without forcing it into its seat (Fig.2).

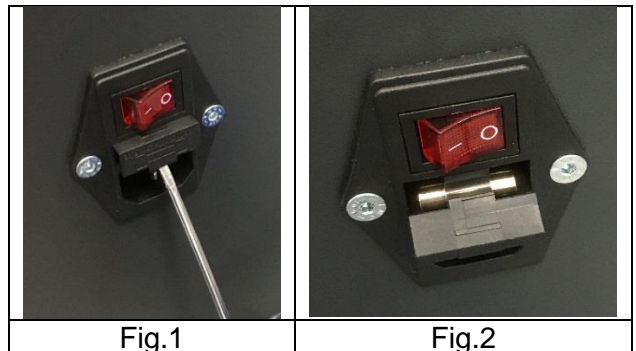

At the end of the operations, power the machine electrically and check its operation.

6. END OF USE

6.1 Preliminary Operations

During the manufacturing process, the MW 8100 machine accumulates dust and substances that can be potentially harmful to health. These substances, as well as the filters it mounts, must be removed before end of use of the machine and must be thrown away in accordance with the laws in force in the country where its demolition takes place.



ATTENTION: This vacuum cleaner may contain dust which is harmful to health.

The operations of removing the filters and cleaning the inside of the machine must only be carried out by specialized personnel, wearing suitable personal protective equipment: gloves, goggles and face filter mask.

Make sure that the machine is not powered and take all necessary measures to prevent it from being inadvertently powered.

6.2 Machine Demolition

The product consists of materials that can be recovered or recycled. Therefore, in the event of scrapping, its components must not be thrown together with municipal or similar waste, but must be sent to separate collection, according to the regulations in force in the country where the demolition takes place.

Disassemble the product and separate the components according to their type, for example: plastic, rubber, metal, electrical or electronic parts; these will subsequently be disposed of separately, using the collection systems provided for by local legislation.

The demolition must be carried out by sufficiently trained personnel, using suitable equipment for the disassembly operations and wearing the appropriate personal protective equipment (gloves, goggles and face mask).



Machine demolition operations must be carried out by Qualified Personnel (PQ), using equipment suitable for the operations to be performed.



All components of the machine must be thrown away in responsible way, in compliance with the legislation in force in the country where the demolition takes place.



The electrical and electronic parts must be thrown away in compliance with the Directive 2012/19 / EU on WEEE waste (Waste from Electrical and Electronic Equipment). The symbol shown on the side, a crossed-out mobile rubbish container, also visible on a plate applied to the machine, indicates that it is mandatory to carry out a specific separate collection. WEEE must therefore be delivered to authorized collection points for the treatment, recovery and recycling of electrical and electronic equipment



Parts of the machine made of plastic, glass, aluminum, steel, etc. must be given to the appropriate authorized collection centers for their recycling. Proper separation facilitates the recovery of important materials. Improper use or incorrect disposal could have negative effects on human health and the environment and are punishable by law



Wear suitable personal protective equipment (PPE) when disassembling the machine: Gloves and goggles to protect yourself from sharp edges, sparks and splinters; Face Mask to protect against soot accumulated in the machine.

7. SPARE PARTS

The user must order spare parts for his machine by contacting our local Authorized Dealer. In case of need, contact our Technical Assistance Service.

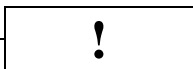







Use only original spare parts. The use of non-original spare parts immediately invalidates the guarantee. MasterWeld declines all responsibility for damage to persons or property caused by the use of non-original spare parts.

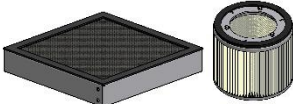

FOR ALL REPLACEMENT OPERATIONS, CONTACT OUR TECHNICAL ASSISTANCE SERVICE.

7.1 SPARE PARTS LIST

Pos.	Description
1)	 <p>MW 8100/CART Cellulose filter cartridge</p>
2)	 <p>MW 8100/CARB Activated carbon cell</p>
3)	 <p>MW 8100/MS Suction brush motor.</p>
4)	 <p>MW 8100/HOSE Flexible hose D60mm L3mt</p>
5)	 <p>MW 8100/CAP Suction hood with support, magnetic base and anti-spark brass-plated cloth</p>
6)	 <p>MW 8100/KIT-FILTERS Filter kit for MW 8100 consisting of cartridge and activated carbon cell (resp. Pos. 1 and 2).</p>
7)	 <p>CA211 Power cable with Shuko socket</p>

When ordering the spare part, clearly indicate the component and the quantity you need.

8. WIRING DIAGRAM

8.1 MW 8100

The MW 8100 machine is equipped with an electric power socket with ignition switch, power light and protection fuses. By acting on the switch, it directly powers the electric motor, starting the suction operations. At the same time the red LED lights up to indicate that the machine is powered and switched on. The following diagram shows the electrical wiring of the machine.

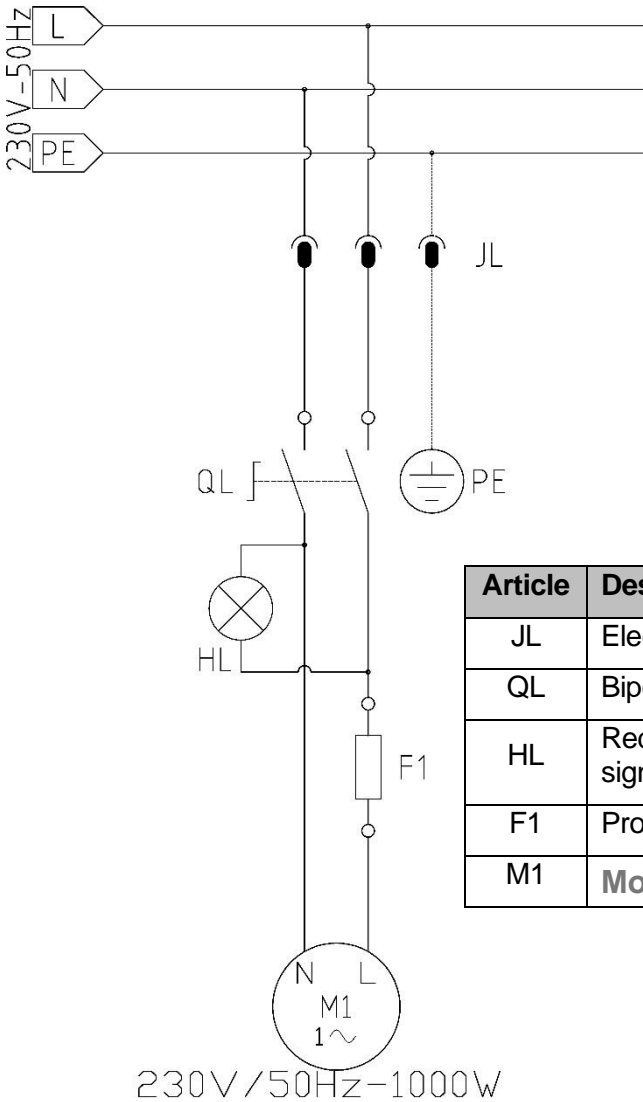

Article	Description	Code
JL	Electric power cable	CA211
QL	Bipolar switch	EM-FS-1606
HL	Red "machine running" signaling LED	
F1	Protection fuse - 8AF	
M1	Motor	MOT-SPAZZ-9084730



Electrical wiring operations must be carried out by Qualified Personnel (PQ), using certified components and materials. Check that the power supply line used to power the machine is connected to the grounding system and that a magnetothermic general switch with differential protection is provided.

9. PROBLEMS, CAUSES, SOLUTIONS

Problems	Causes	Solutions	Staff
Failure to start the machine	Blown fuse	Check the condition of the fuse with a tester	PQ
	Too low voltage	Check the voltage of the electrical distribution network with a tester	PQ
	Problems with the power supply cable	Check and replace the component if necessary	U
	Problems with the electric motor	Check and replace the component if necessary	TA
The emitted air is not sufficiently purified	Ineffective action of filters	Check the condition of the filters and replace them	PQ
The machine does not develop sufficient suction capacity	Clogged and dirty filters	Check the condition of the filters and replace them	PQ
	Physical impediments and / or occlusions	Check that there are no foreign bodies inside the hose, otherwise remove them	PQ
	Torn or damaged hose	Check the condition of the hose and replace it if damaged	PQ
	Problems with the electric motor	Check and replace the component if necessary	TA
Differential protection intervention (circuit breaker) of the power supply system	Ground fault in the machine	Check the electrical insulation of the machine frame with a tester	TA
	Short circuit (in the electric motor)	Check and replace the component if necessary	TA

NOTES:

A large rectangular area with a solid black border, containing 20 horizontal dashed lines for writing notes.

Contacts and Numbers:

			
	<p>Importer & Distributor of MasterWeld Products; AES Industrial Supplies Ltd Olympic House, Collet, Southmead Industrial Park, Didcot, Oxon OX11 7WB</p>	<p>Tel. +44 (0) 1235 510717 Fax. +44 (0) 1235 818610</p> <p>www.masterweld.com</p>	<p>orders@aes-sales.com</p>